

This drawing contains information which is the property of Woodgrain Millwork, Inc. This drawing is received on confidence and contents may not be disclosed without the prior written consent of Woodgrain Millwork, Inc.

742

Draw #:	Taper 742_36_80_4
Date:	09 - 04 - 16
Drawn By:	T Doughty

woodgrain doors

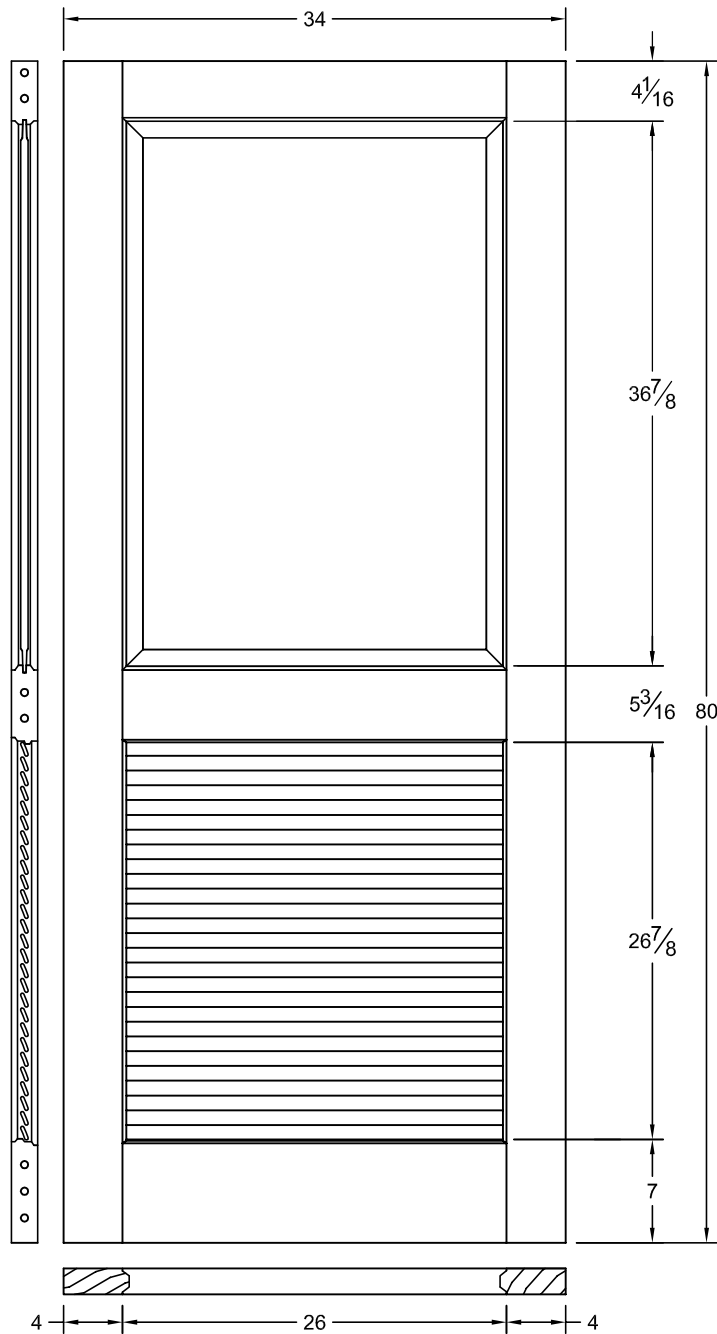

This drawing contains information which is the property of Woodgrain Millwork, Inc. This drawing is received on confidence and contents may not be disclosed without the prior written consent of Woodgrain Millwork, Inc.

742

Draw #:	Taper 742_34_80_4
Date:	09 - 04 - 16
Drawn By:	T Doughty

 woodgrain doors

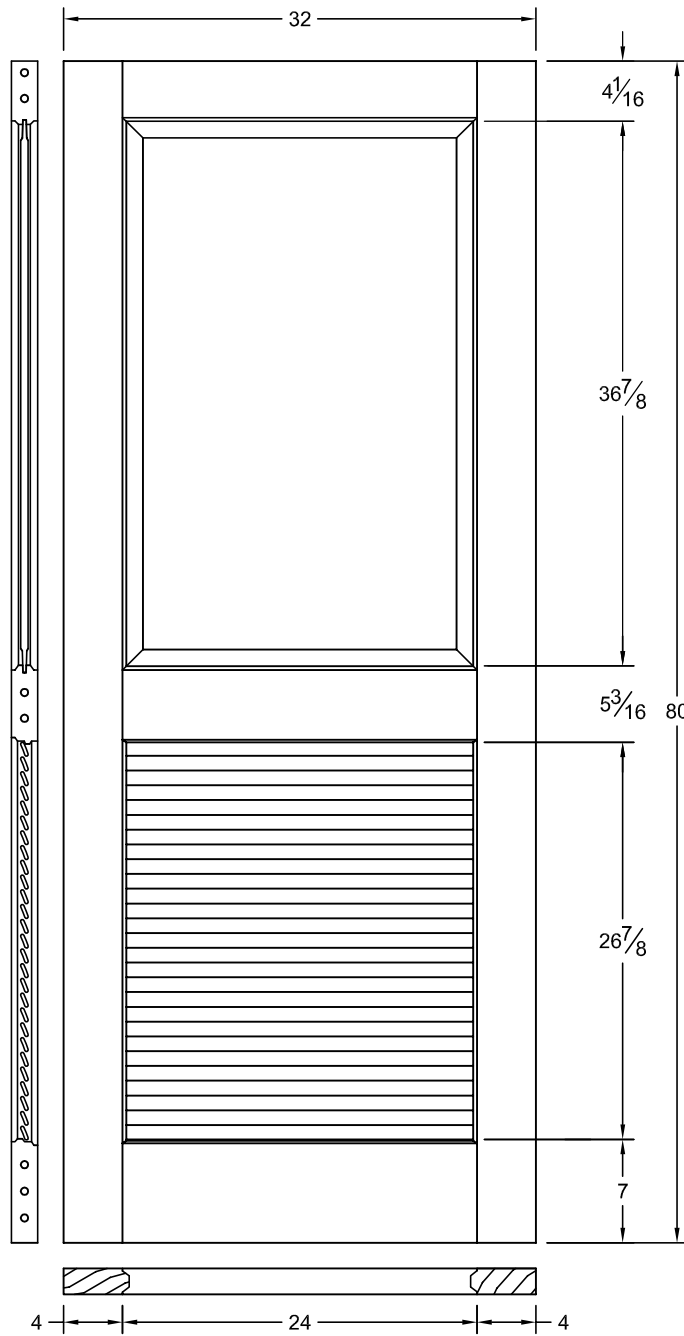

of louvers
in bottom section
27

This drawing contains information which is the property of Woodgrain Millwork, Inc. This drawing is received on confidence and contents may not be disclosed without the prior written consent of Woodgrain Millwork, Inc.

742

Draw #:	Taper 742_32_80_4
Date:	09 - 04 - 16
Drawn By:	T Doughty

woodgrain doors

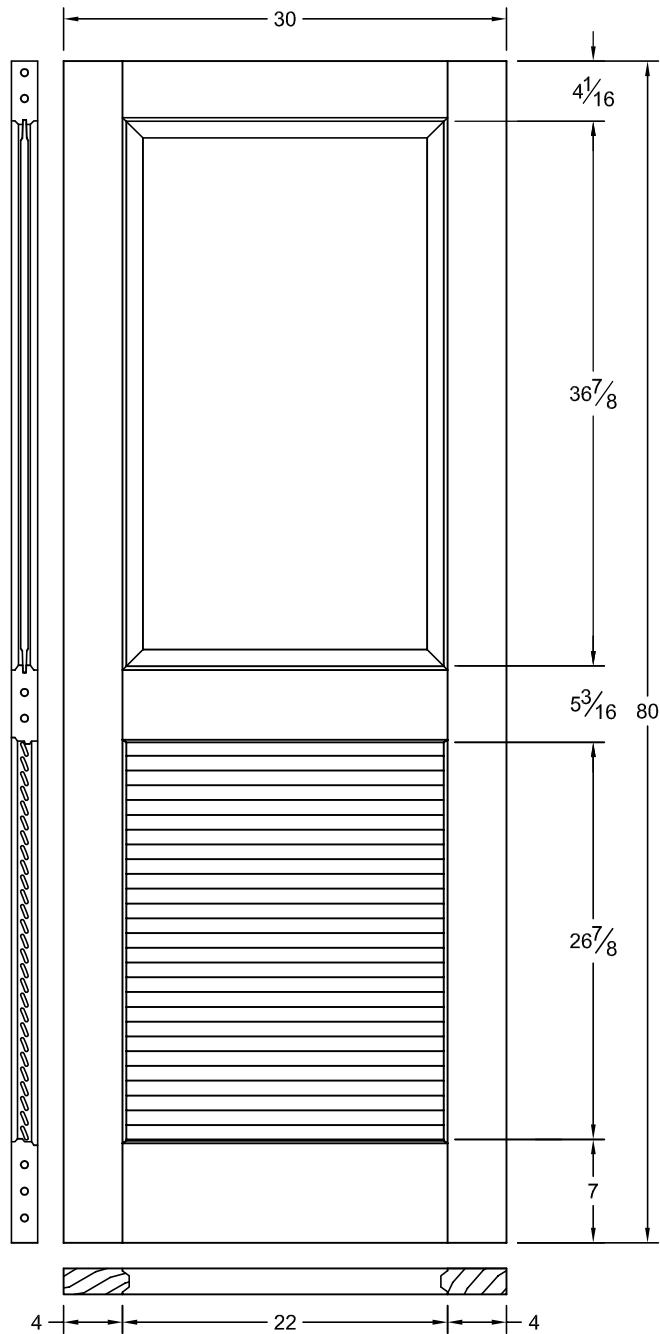

of louvers
in bottom section
27

This drawing contains information which is the property of Woodgrain Millwork, Inc. This drawing is received on confidence and contents may not be disclosed without the prior written consent of Woodgrain Millwork, Inc.

742

Draw #:	Taper 742_30_80_4
Date:	09 - 04 - 16
Drawn By:	T Doughty

 woodgrain doors

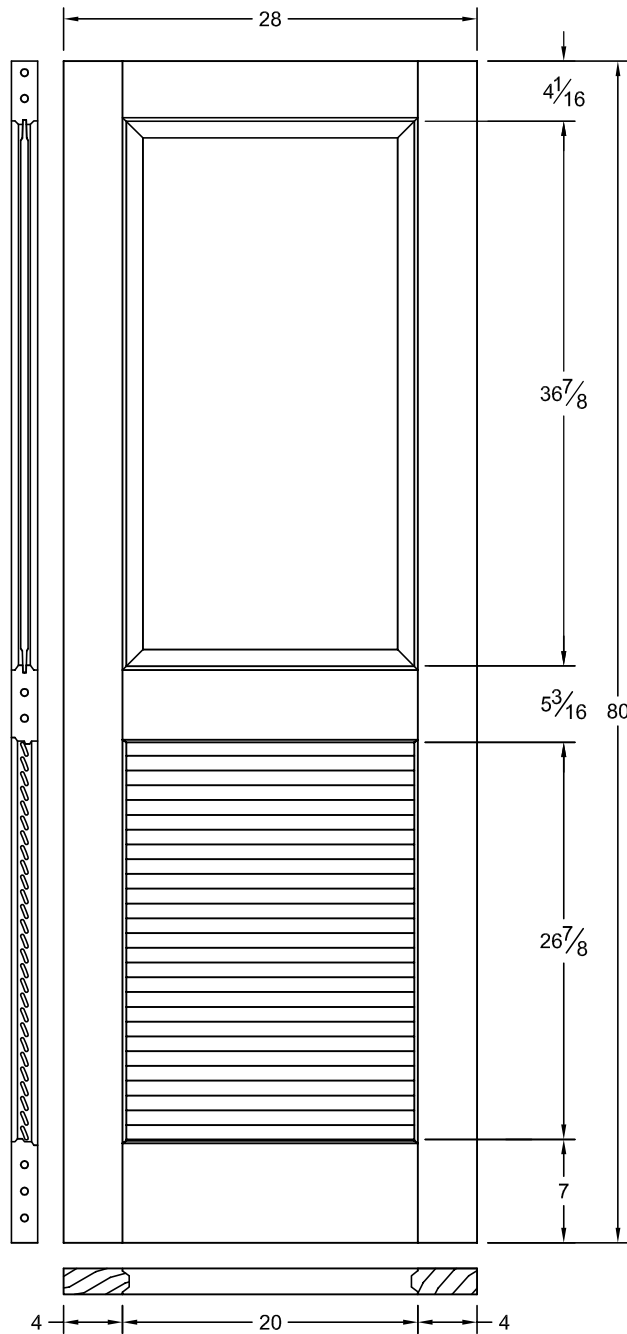

of louvers
in bottom section
27

This drawing contains information which is the property of Woodgrain Millwork, Inc. This drawing is received on confidence and contents may not be disclosed without the prior written consent of Woodgrain Millwork, Inc.

742

Draw #:	Taper 742_28_80_4
Date:	09 - 04 - 16
Drawn By:	T Doughty

woodgrain doors

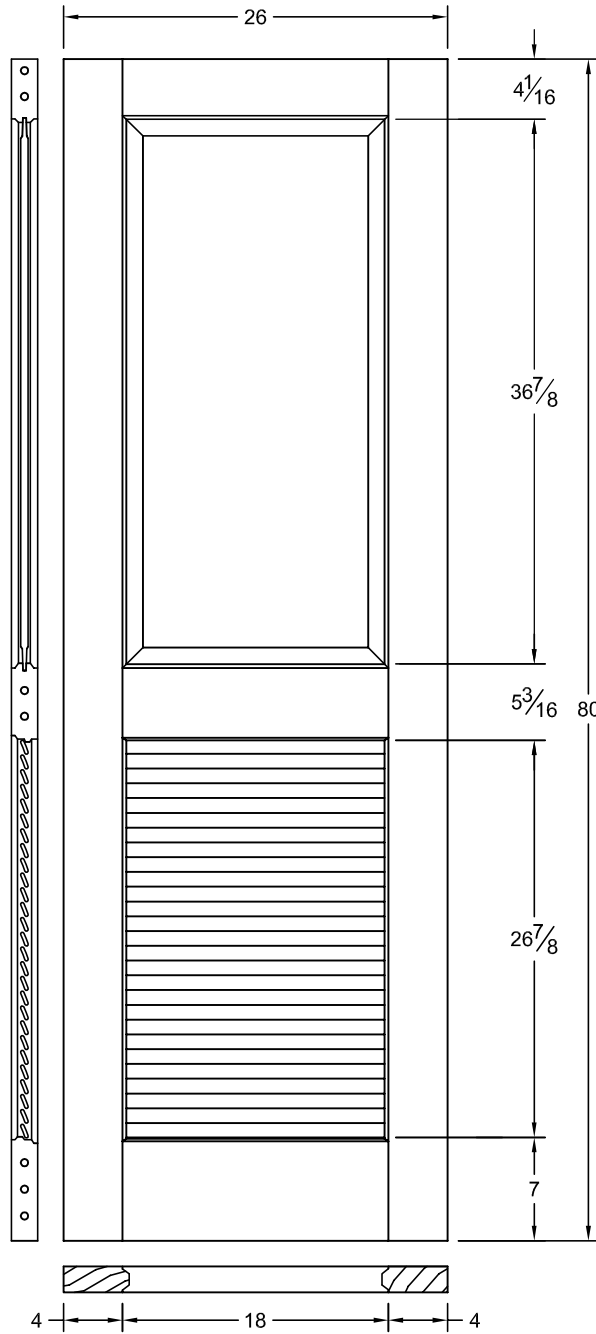

of louvers
in bottom section
27

This drawing contains information which is the property of Woodgrain Millwork, Inc. This drawing is received on confidence and contents may not be disclosed without the prior written consent of Woodgrain Millwork, Inc.

742

Draw #:	Taper 742_26_80_4
Date:	09 - 04 - 16
Drawn By:	T Doughty

woodgrain doors

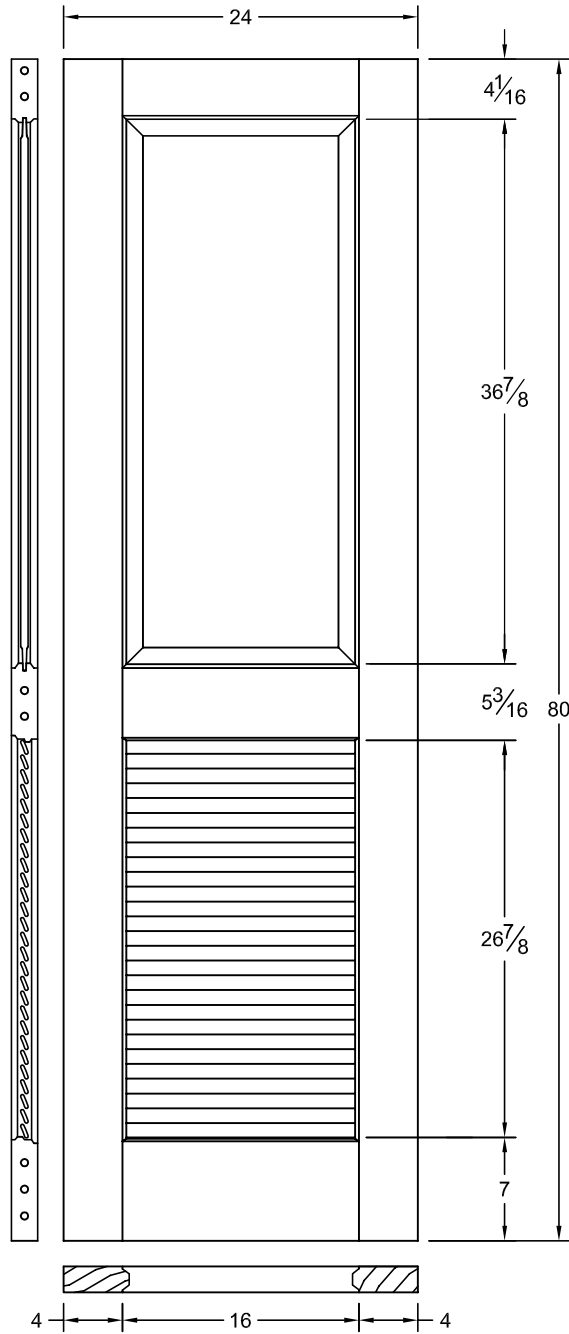

of louvers
in bottom section
27

This drawing contains information which is the property of Woodgrain Millwork, Inc. This drawing is received on confidence and contents may not be disclosed without the prior written consent of Woodgrain Millwork, Inc.

742

Draw #:	Taper 742_24_80_4
Date:	09 - 04 - 16
Drawn By:	T Doughty

woodgrain doors

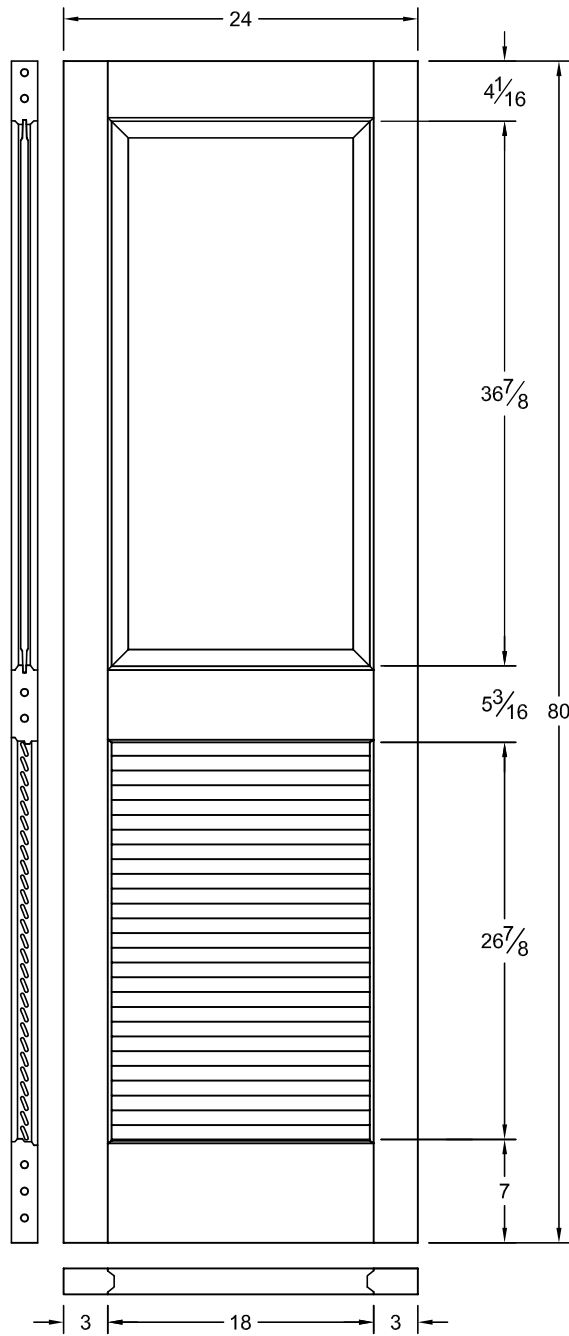

This drawing contains information which is the property of Woodgrain Millwork, Inc. This drawing is received on confidence and contents may not be disclosed without the prior written consent of Woodgrain Millwork, Inc.

742

Draw #:	Taper 742_24_80_3
Date:	09 - 04 - 16
Drawn By:	T Doughty



of louvers
in bottom section
27

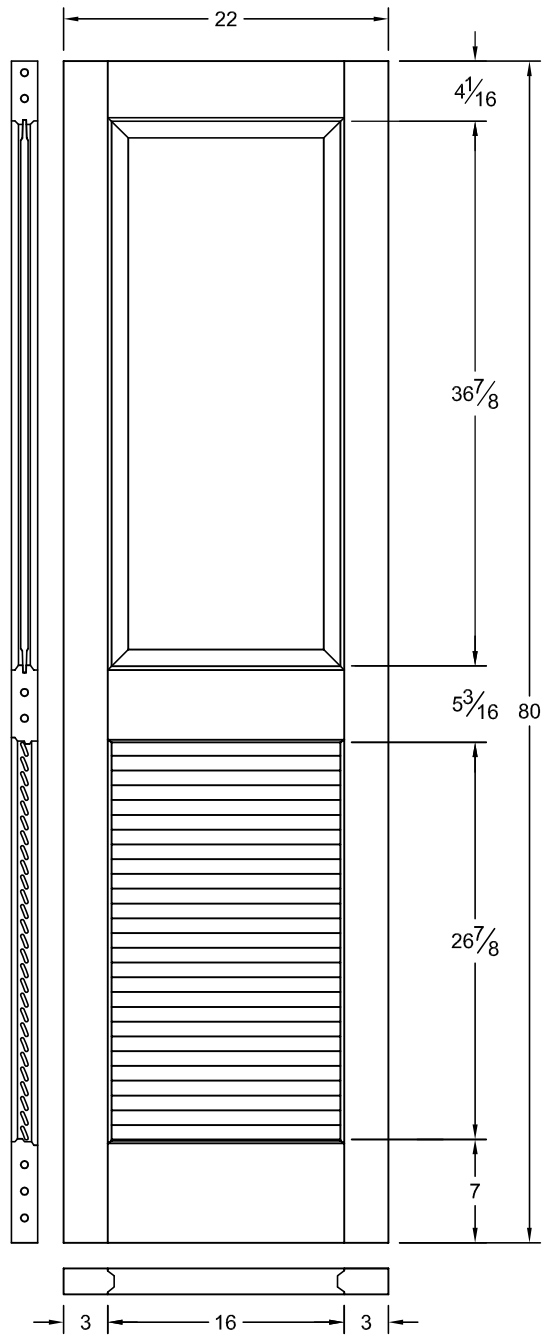

This drawing contains information which is the property of Woodgrain Millwork, Inc. This drawing is received on confidence and contents may not be disclosed without the prior written consent of Woodgrain Millwork, Inc.

742

Draw #:	Taper 742_22_80_3
Date:	09 - 04 - 16
Drawn By:	T Doughty



of louvers
in bottom section
27

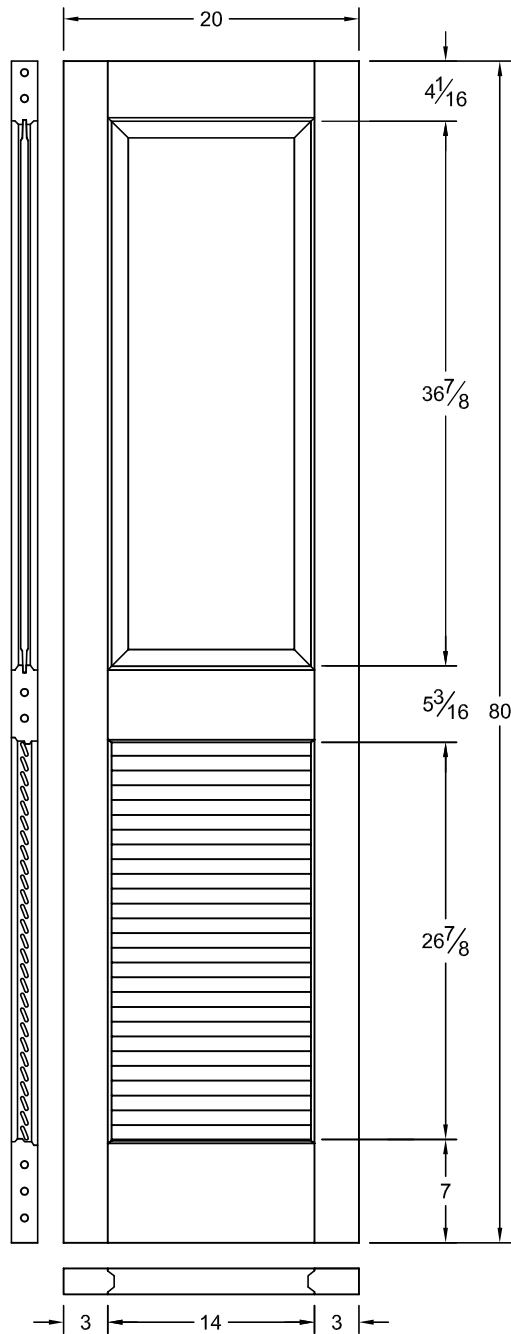

This drawing contains information which is the property of Woodgrain Millwork, Inc. This drawing is received on confidence and contents may not be disclosed without the prior written consent of Woodgrain Millwork, Inc.

742

Draw #:	Taper 742_20_80_3
Date:	09 - 04 - 16
Drawn By:	T Doughty

woodgrain doors

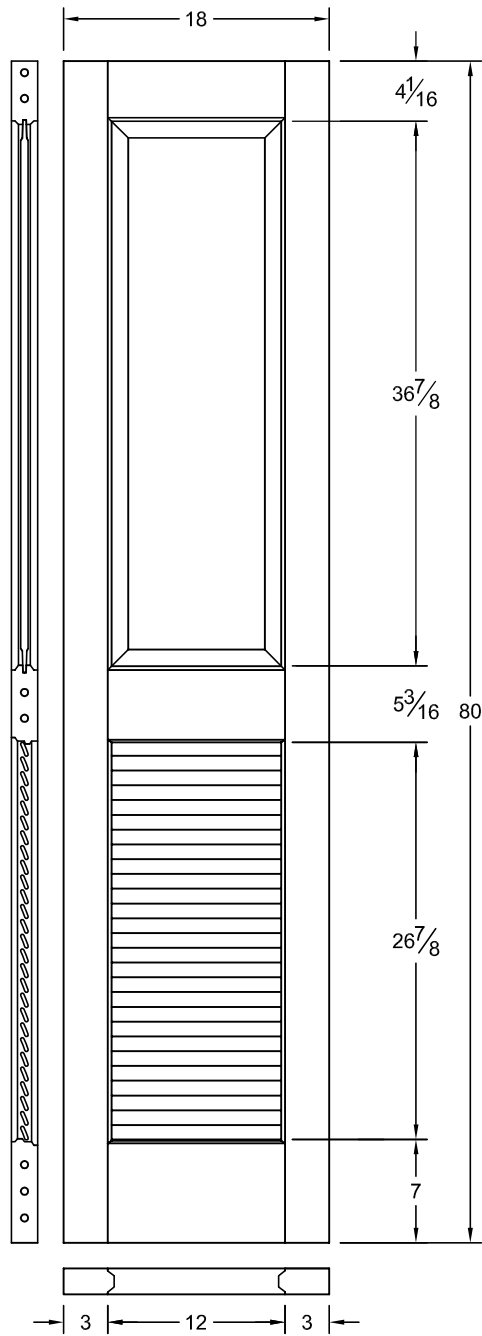

of louvers
in bottom section
27

This drawing contains information which is the property of Woodgrain Millwork, Inc. This drawing is received on confidence and contents may not be disclosed without the prior written consent of Woodgrain Millwork, Inc.

742

Draw #:	Taper 742_18_80_3
Date:	09 - 04 - 16
Drawn By:	T Doughty

woodgrain doors

of louvers
in bottom section
27

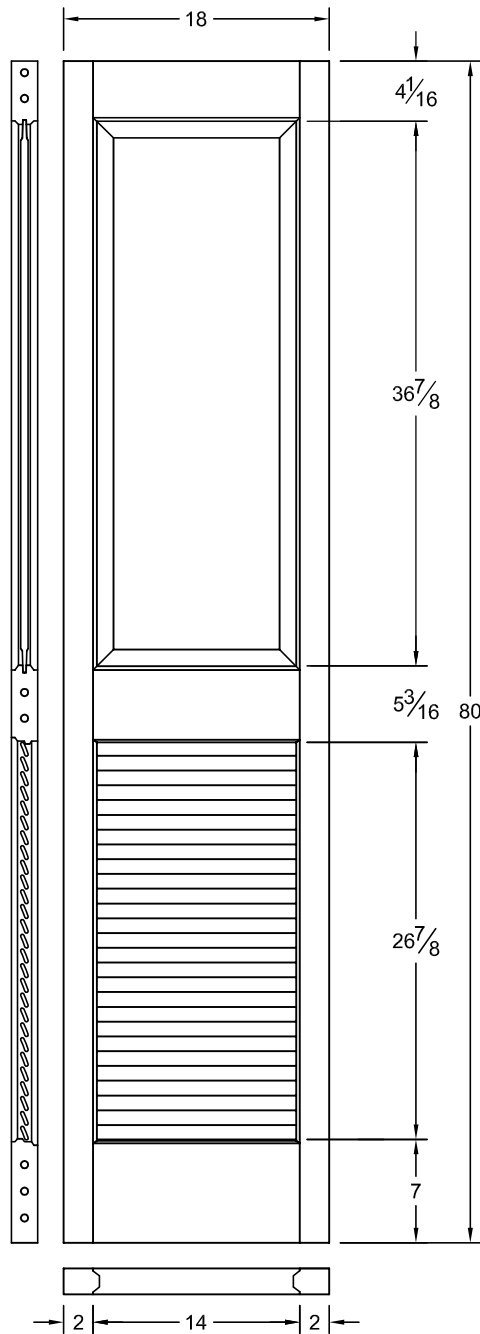

This drawing contains information which is the property of Woodgrain Millwork, Inc. This drawing is received on confidence and contents may not be disclosed without the prior written consent of Woodgrain Millwork, Inc.

742

Draw #:	Taper 742_18_80_2
Date:	09 - 04 - 16
Drawn By:	T Doughty



of louvers
in bottom section
27

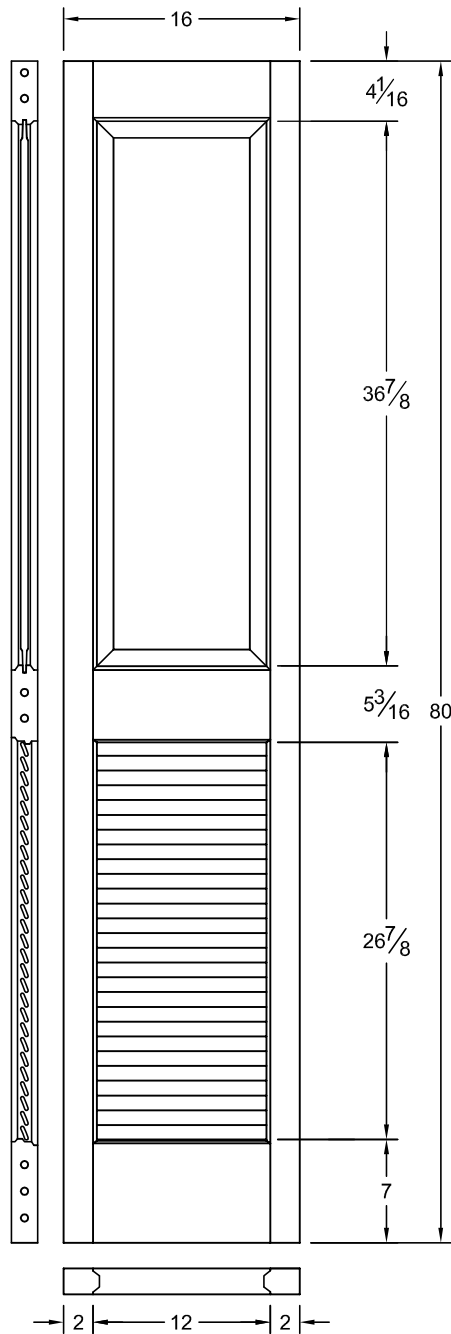

This drawing contains information which is the property of Woodgrain Millwork, Inc. This drawing is received on confidence and contents may not be disclosed without the prior written consent of Woodgrain Millwork, Inc.

742

Draw #:	Taper 742_16_80_2
Date:	09 - 04 - 16
Drawn By:	T Doughty



of louvers
in bottom section
27

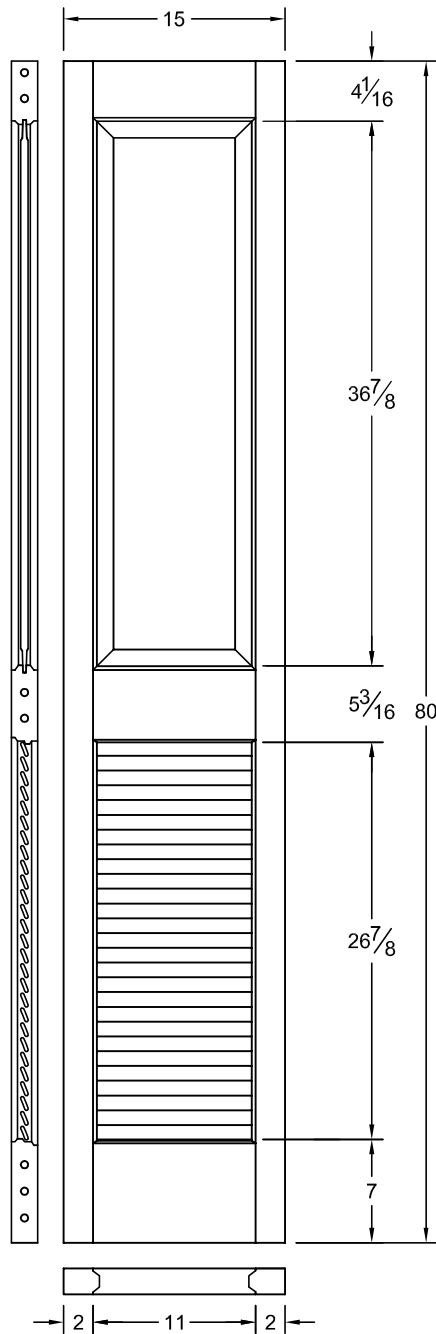

This drawing contains information which is the property of Woodgrain Millwork, Inc. This drawing is received on confidence and contents may not be disclosed without the prior written consent of Woodgrain Millwork, Inc.

742

Draw #:	Taper 742_15_80_2
Date:	09 - 04 - 16
Drawn By:	T Doughty

woodgrain doors

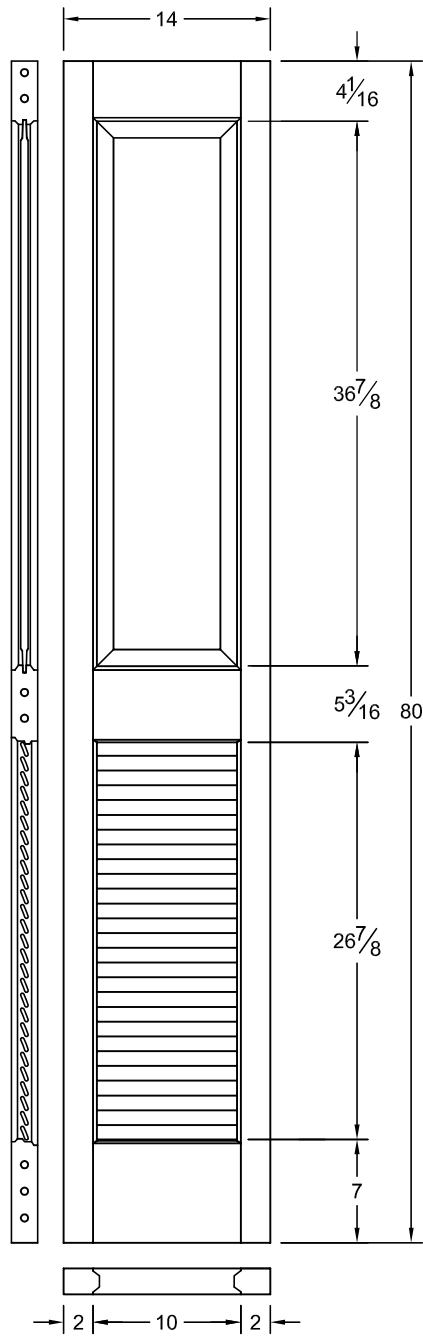

of louvers
in bottom section
27

This drawing contains information which is the property of Woodgrain Millwork, Inc. This drawing is received on confidence and contents may not be disclosed without the prior written consent of Woodgrain Millwork, Inc.

742

Draw #:	Taper 742_14_80_2
Date:	09 - 04 - 16
Drawn By:	T Doughty



of louvers
in bottom section
27

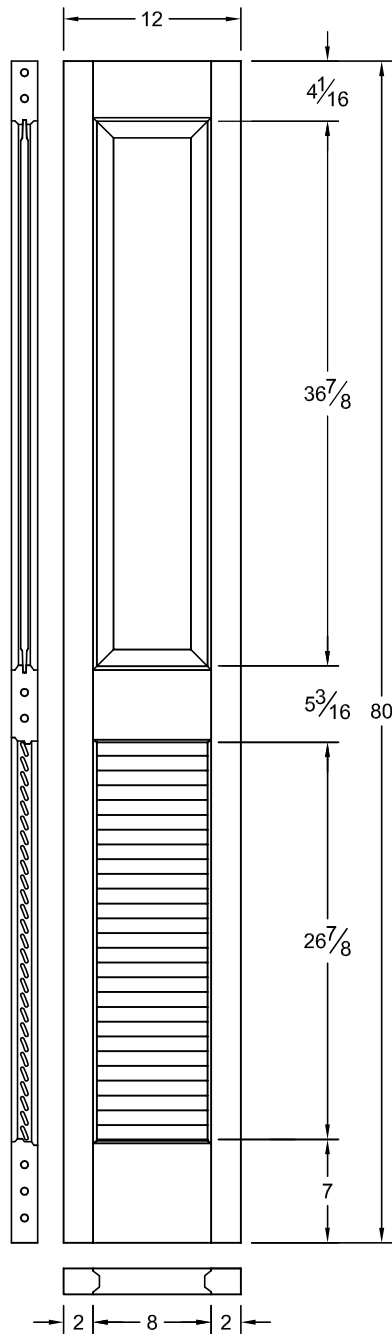

This drawing contains information which is the property of Woodgrain Millwork, Inc. This drawing is received on confidence and contents may not be disclosed without the prior written consent of Woodgrain Millwork, Inc.

742

Draw #:	Taper 742_12_80_2
Date:	09 - 04 - 16
Drawn By:	T Doughty

woodgrain doors