

This drawing contains information which is the property of Woodgrain Millwork, Inc. This drawing is received on confidence and contents may not be disclosed without the prior written consent of Woodgrain Millwork, Inc.

4857

Draw #:	Shaker 4857_36_80	
Date:	10 - 16 - 14	R1
Drawn By:	T Doughty	

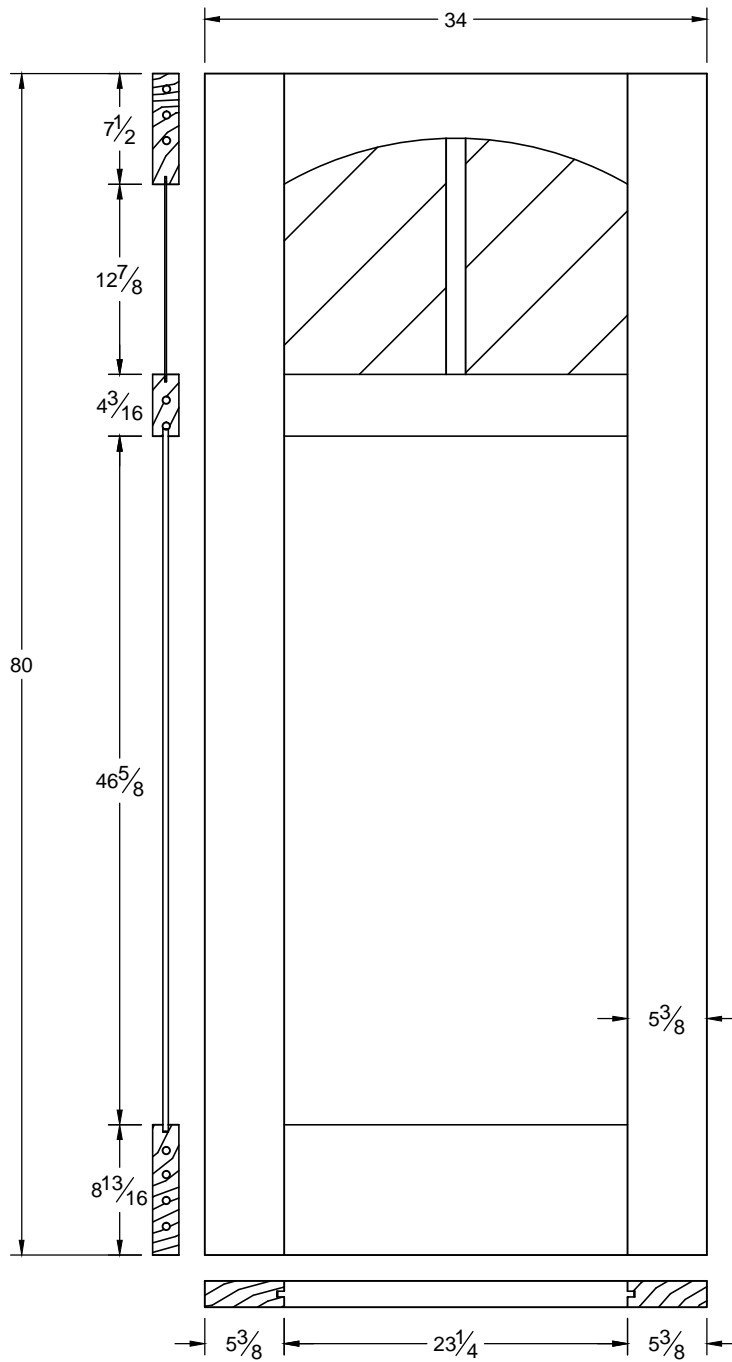



This drawing contains information which is the property of Woodgrain Millwork, Inc. This drawing is received on confidence and contents may not be disclosed without the prior written consent of Woodgrain Millwork, Inc.

4857

Draw #:	Shaker 4857_34_80	
Date:	10 - 16 - 14	R1
Drawn By:	T Doughty	

 woodgrain doors

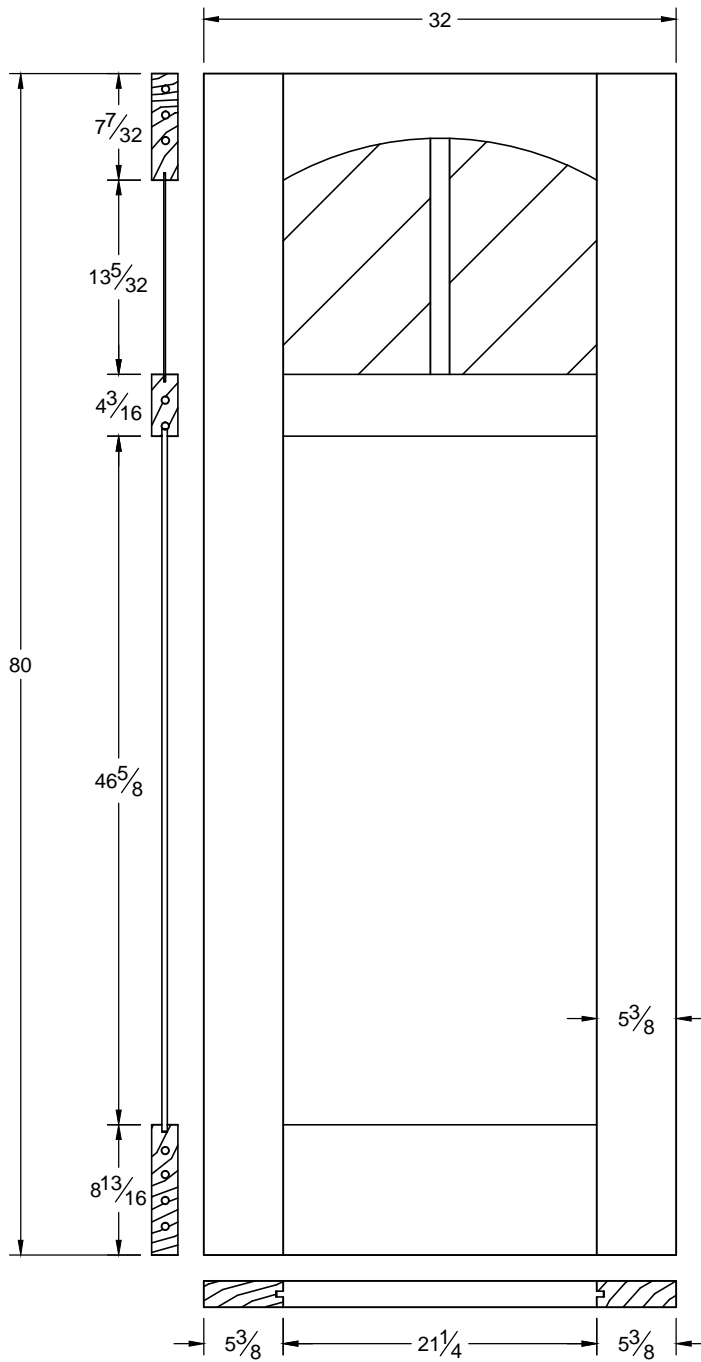

This drawing contains information which is the property of Woodgrain Millwork, Inc. This drawing is received on confidence and contents may not be disclosed without the prior written consent of Woodgrain Millwork, Inc.

4857

Draw #:	Shaker 4857_32_80	
Date:	10 - 16 - 14	R1
Drawn By:	T Doughty	



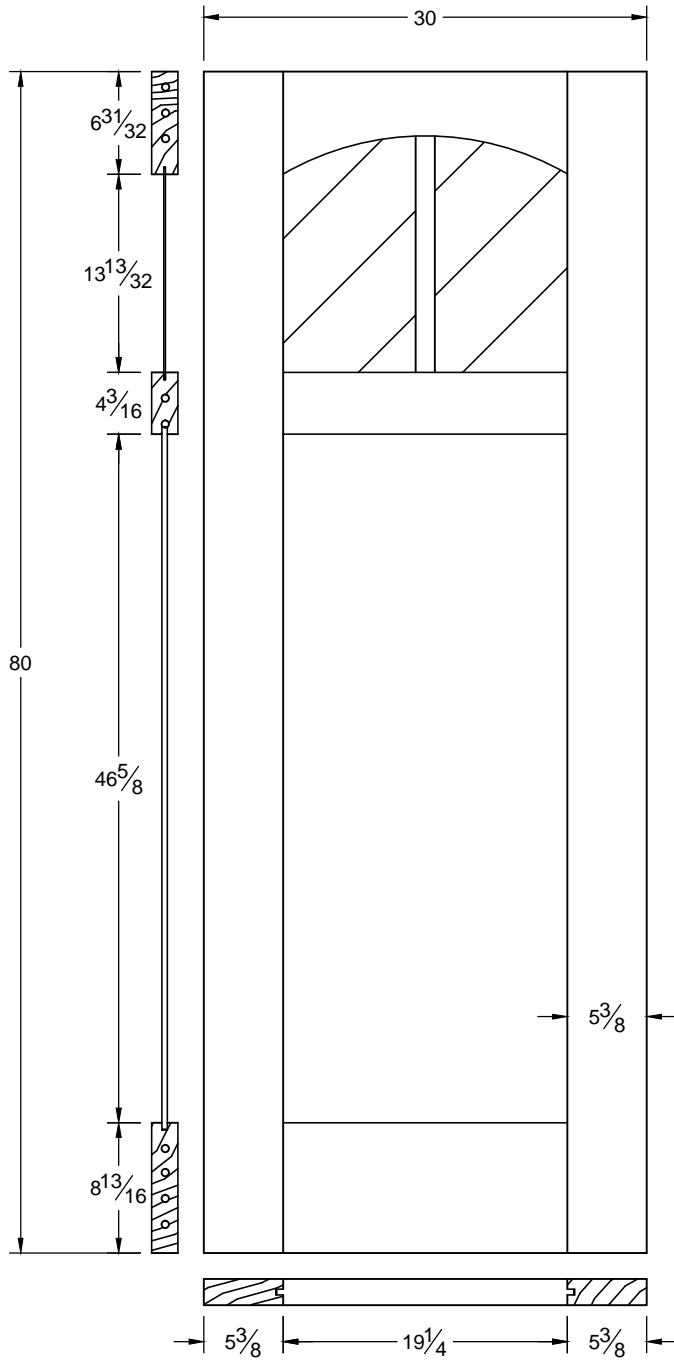

This drawing contains information which is the property of Woodgrain Millwork, Inc. This drawing is received on confidence and contents may not be disclosed without the prior written consent of Woodgrain Millwork, Inc.

4857

Draw #:	Shaker 4857_30_80	
Date:	10 - 16 - 14	R1
Drawn By:	T Doughty	



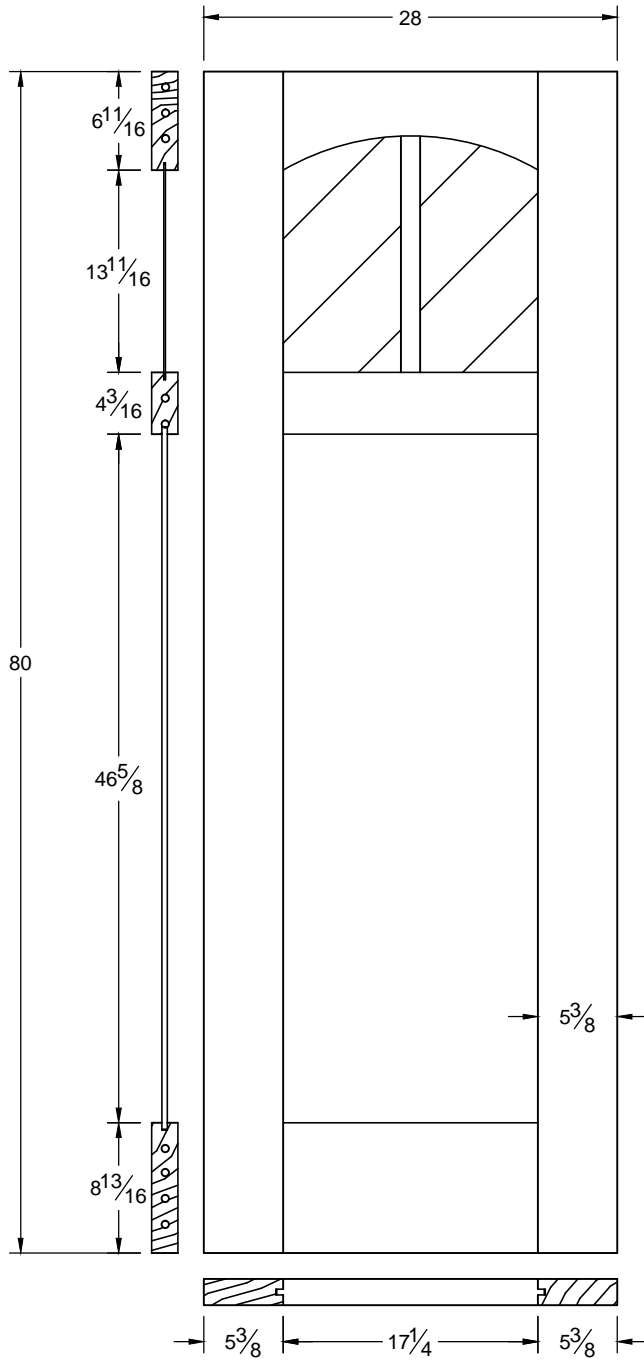

This drawing contains information which is the property of Woodgrain Millwork, Inc. This drawing is received on confidence and contents may not be disclosed without the prior written consent of Woodgrain Millwork, Inc.

4857

Draw #:	Shaker 4857_28_80	
Date:	10 - 16 - 14	R1
Drawn By:	T Doughty	



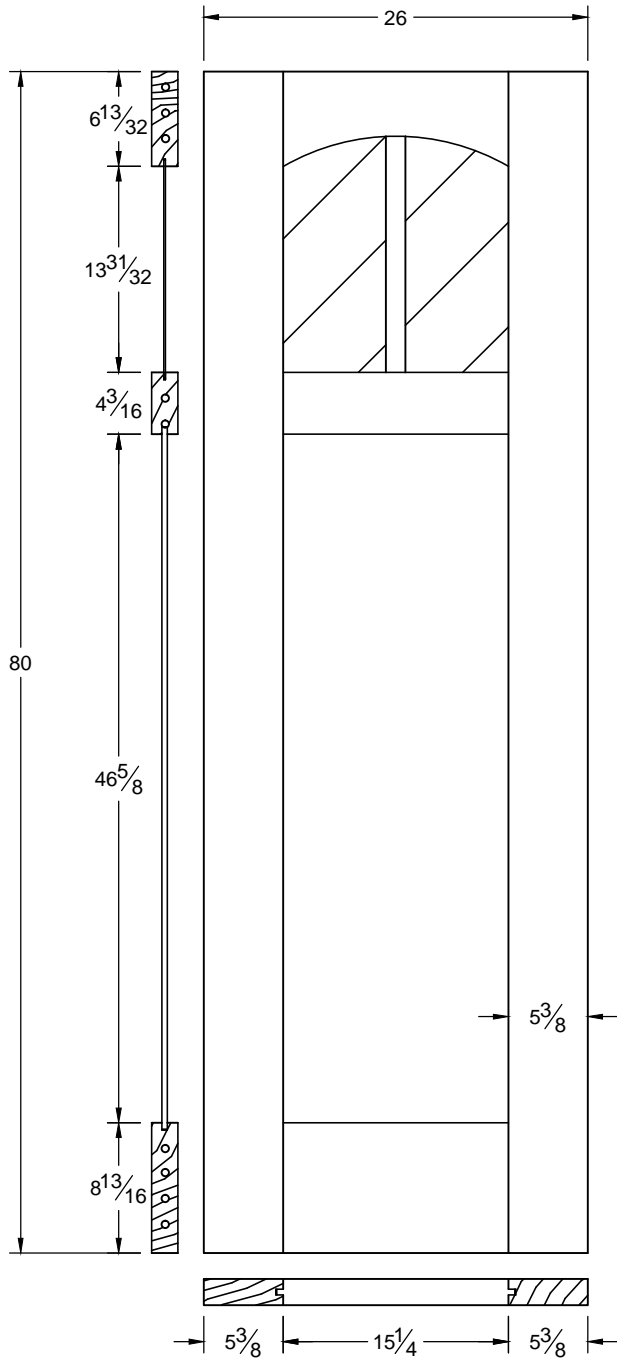

This drawing contains information which is the property of Woodgrain Millwork, Inc. This drawing is received on confidence and contents may not be disclosed without the prior written consent of Woodgrain Millwork, Inc.

4857

Draw #:	Shaker 4857_26_80	
Date:	10 - 16 - 14	R1
Drawn By:	T Doughty	



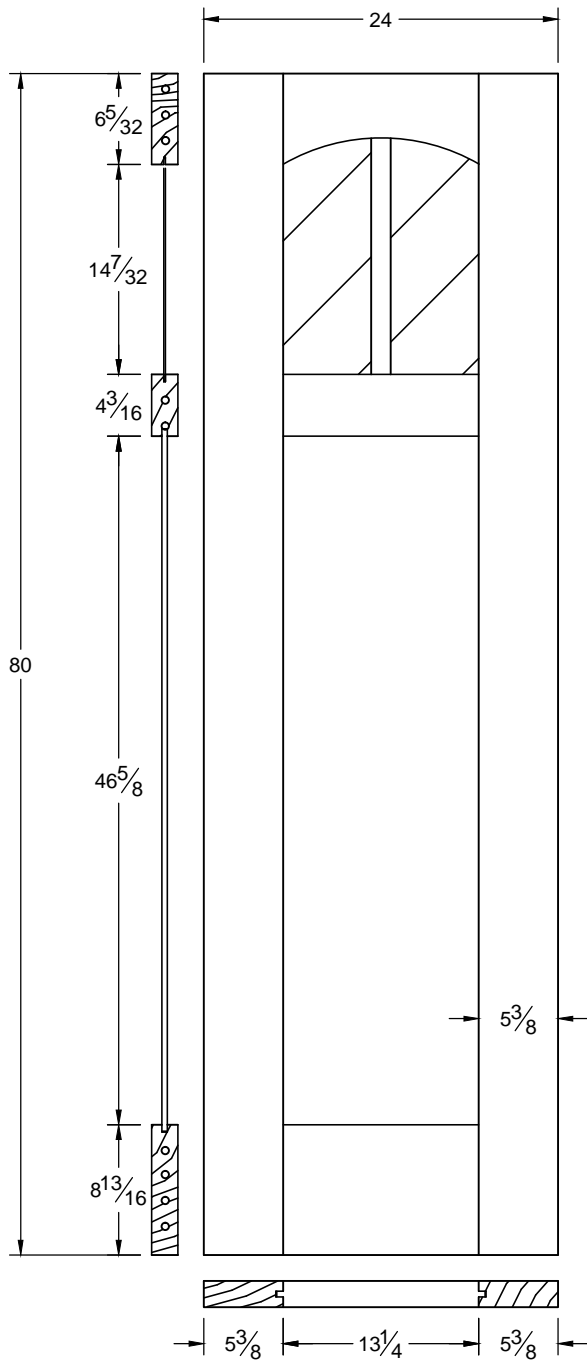

This drawing contains information which is the property of Woodgrain Millwork, Inc. This drawing is received on confidence and contents may not be disclosed without the prior written consent of Woodgrain Millwork, Inc.

4857

Draw #:	Shaker 4857_24_80	
Date:	10 - 16 - 14	R1
Drawn By:	T Doughty	

