

This drawing contains information which is the property of Woodgrain Millwork, Inc. This drawing is received on confidence and contents may not be disclosed without the prior written consent of Woodgrain Millwork, Inc.

4535

Draw #:	Shaker 4535_36_80	
Date:	10 - 16 - 14	R1
Drawn By:	T Doughty	

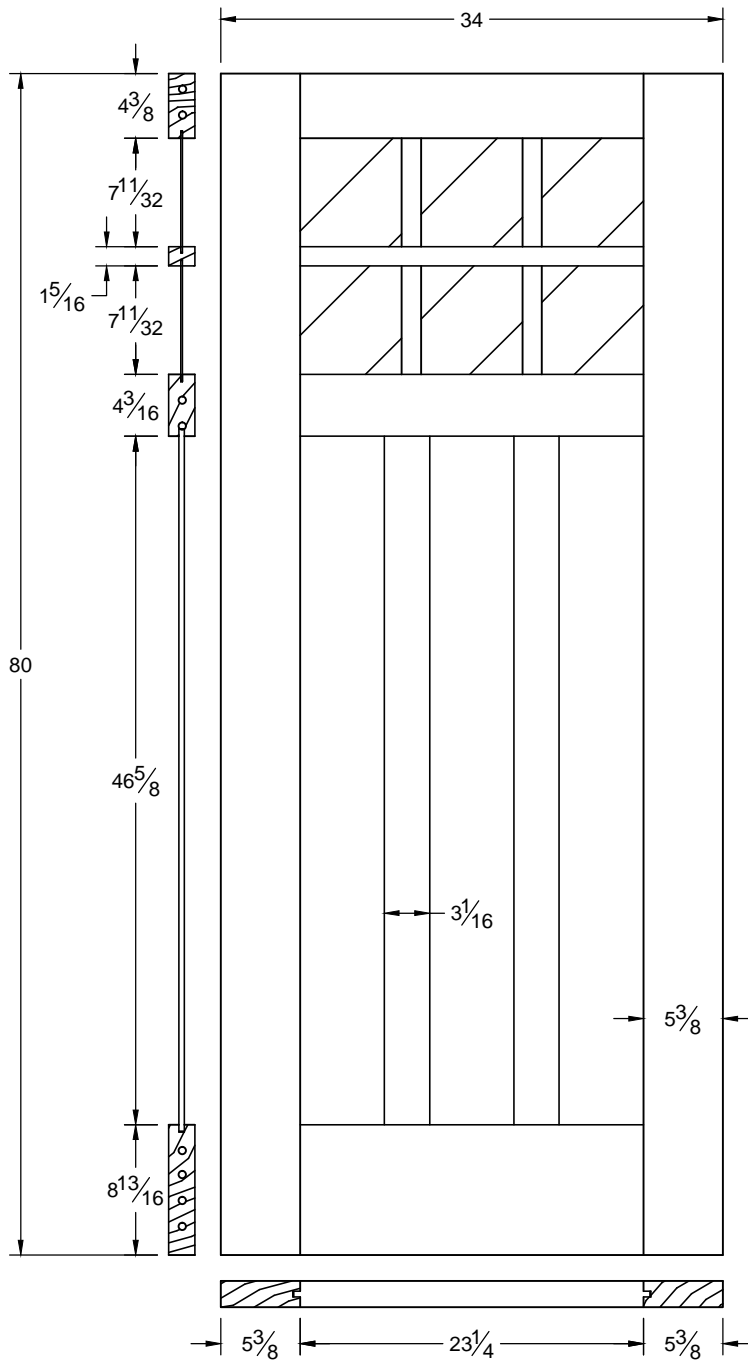



This drawing contains information which is the property of Woodgrain Millwork, Inc. This drawing is received on confidence and contents may not be disclosed without the prior written consent of Woodgrain Millwork, Inc.

4535

Draw #:	Shaker 4535_34_80	
Date:	10 - 16 - 14	R1
Drawn By:	T Doughty	



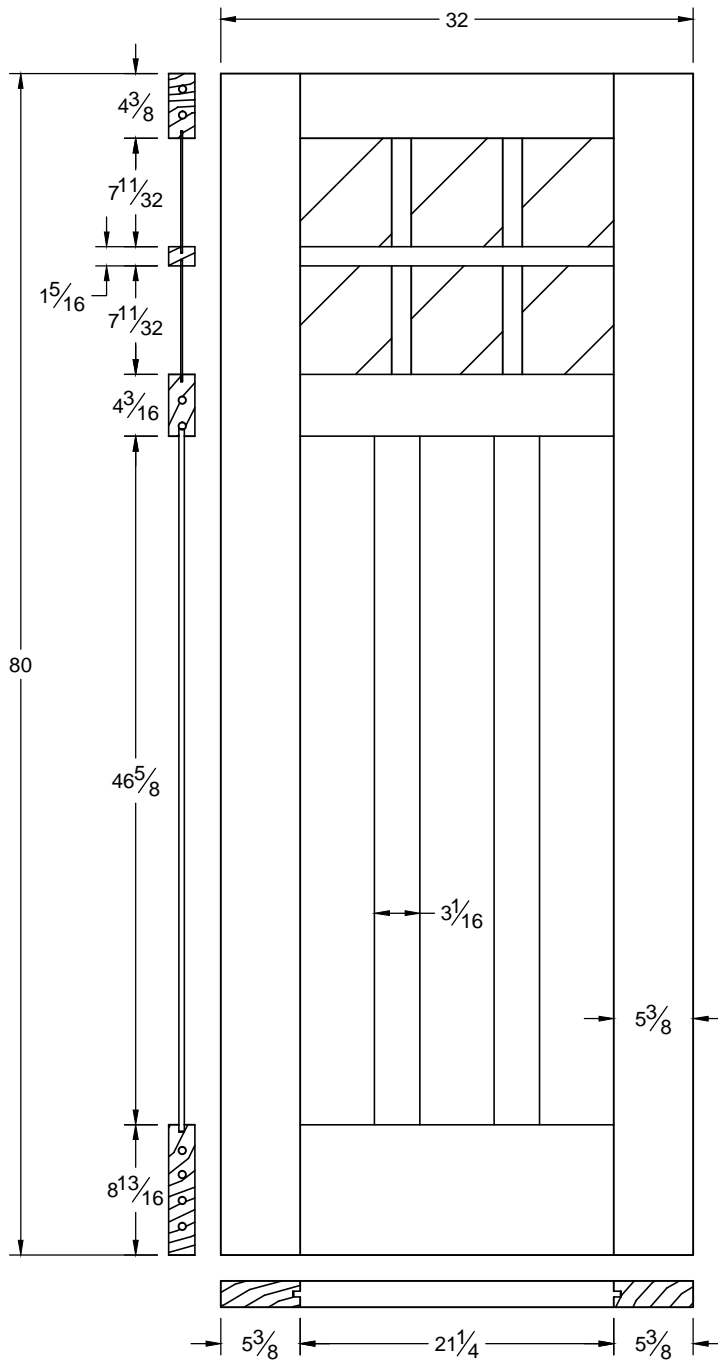

This drawing contains information which is the property of Woodgrain Millwork, Inc. This drawing is received on confidence and contents may not be disclosed without the prior written consent of Woodgrain Millwork, Inc.

4535

Draw #:	Shaker 4535_32_80	
Date:	10 - 16 - 14	R1
Drawn By:	T Doughty	

