

This drawing contains information which is the property of Woodgrain Millwork, Inc. This drawing is received on confidence and contents may not be disclosed without the prior written consent of Woodgrain Millwork, Inc.

4180

Draw #:	Shaker 4180_48_96
Date:	06 - 26 - 17
Drawn By:	T Doughty

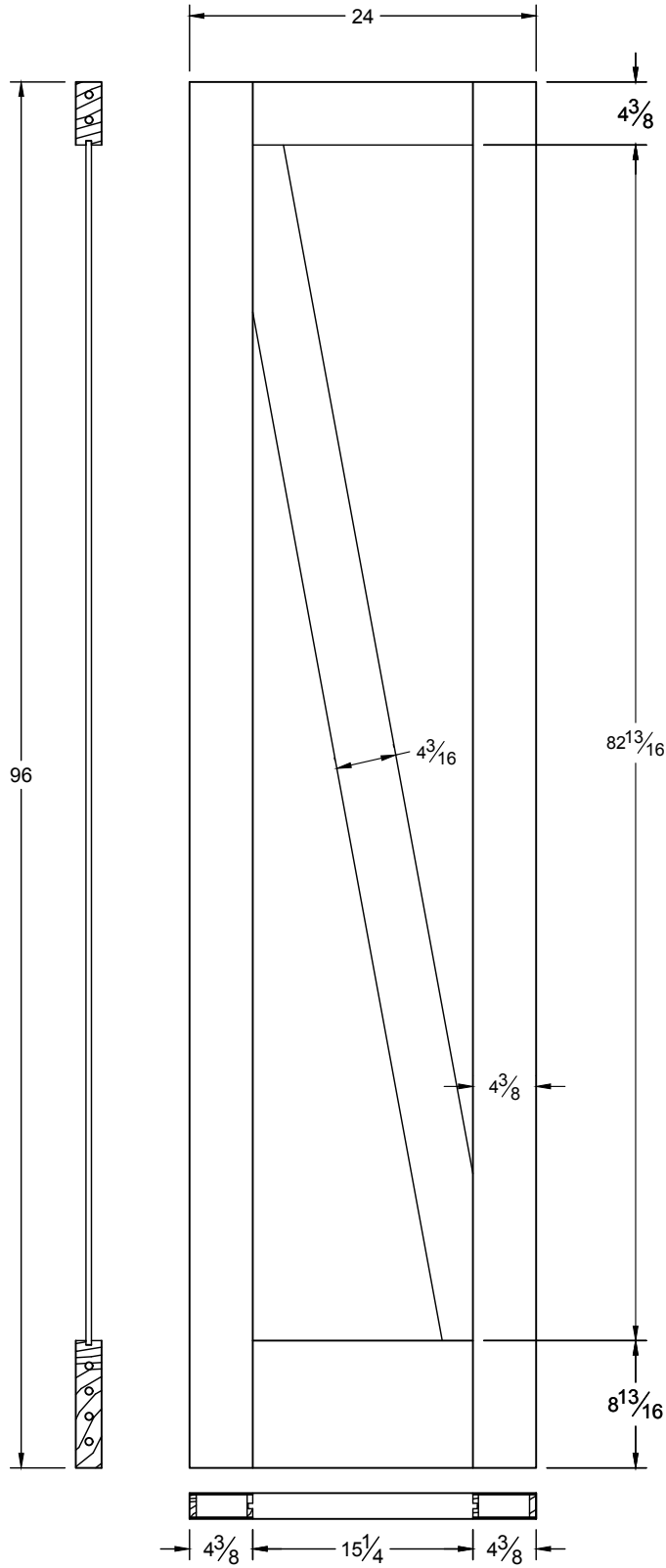



This drawing contains information which is the property of Woodgrain Millwork, Inc. This drawing is received on confidence and contents may not be disclosed without the prior written consent of Woodgrain Millwork, Inc.

4180

Draw #:	Shaker 4180_24_96
Date:	11 - 18 - 18
Drawn By:	T Doughty

 woodgrain doors

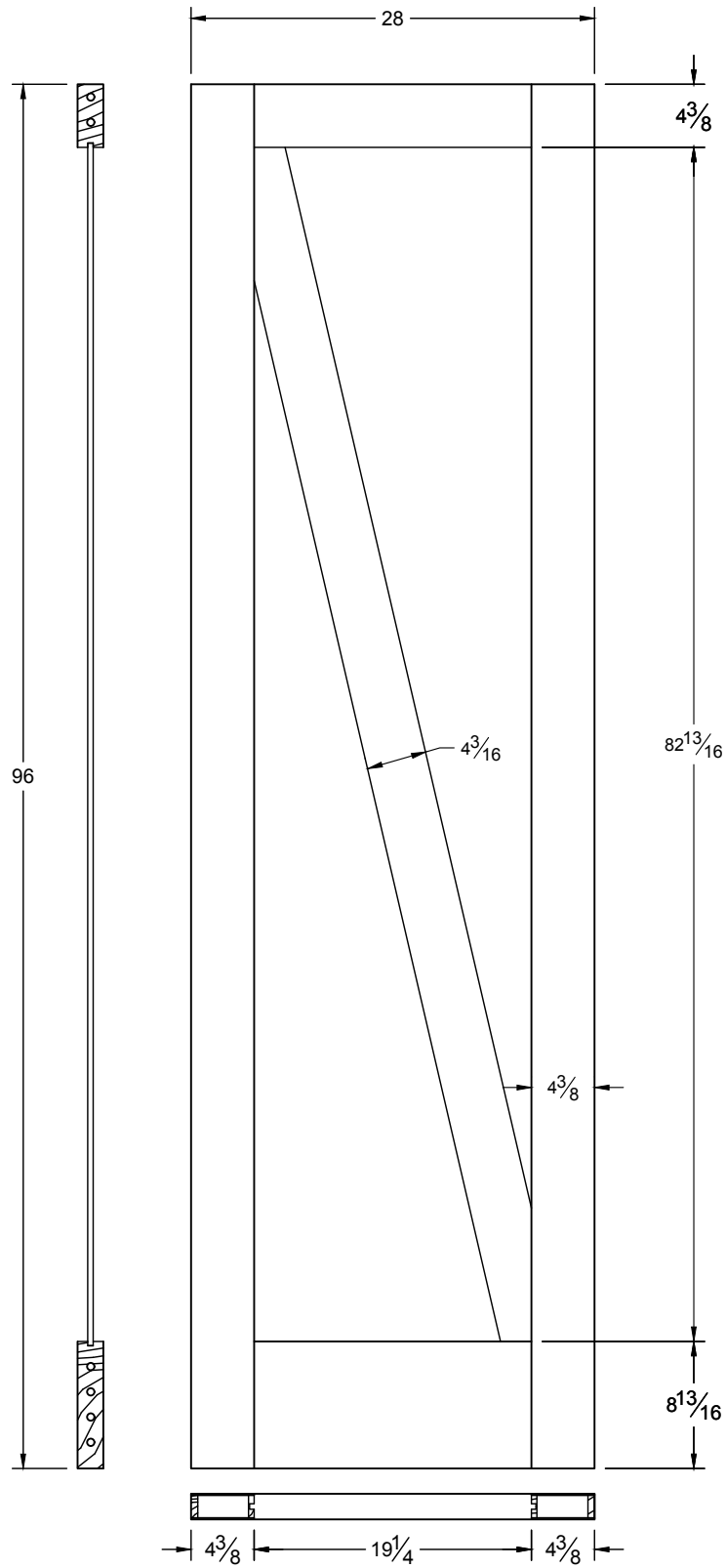

This drawing contains information which is the property of Woodgrain Millwork, Inc. This drawing is received on confidence and contents may not be disclosed without the prior written consent of Woodgrain Millwork, Inc.

4180

Draw #:	Shaker 4180_28_96
Date:	07 - 16 - 18
Drawn By:	T Doughty

woodgrain doors

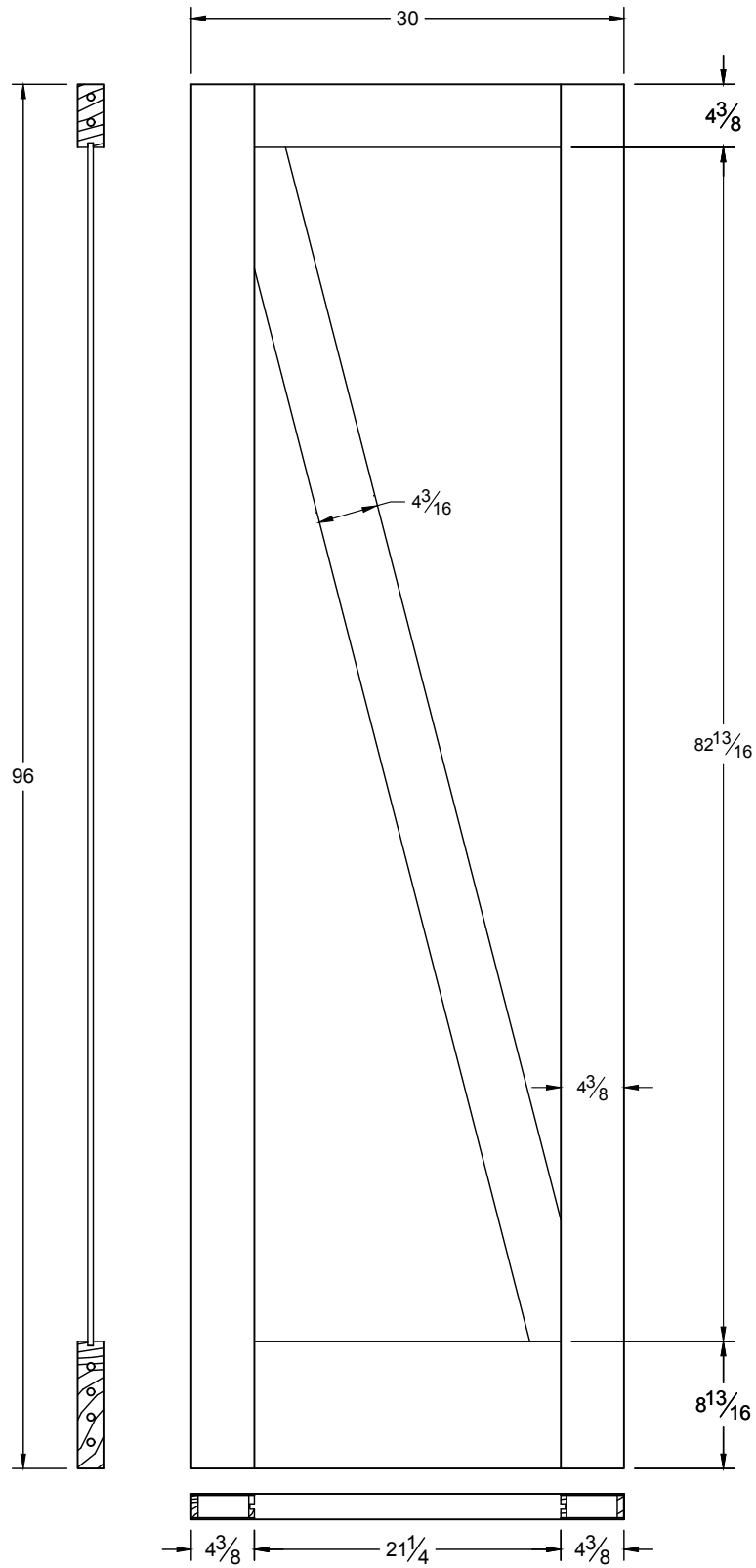

This drawing contains information which is the property of Woodgrain Millwork, Inc. This drawing is received on confidence and contents may not be disclosed without the prior written consent of Woodgrain Millwork, Inc.

4180

Draw #:	Shaker 4180_30_96
Date:	11 - 16 - 18
Drawn By:	T Doughty



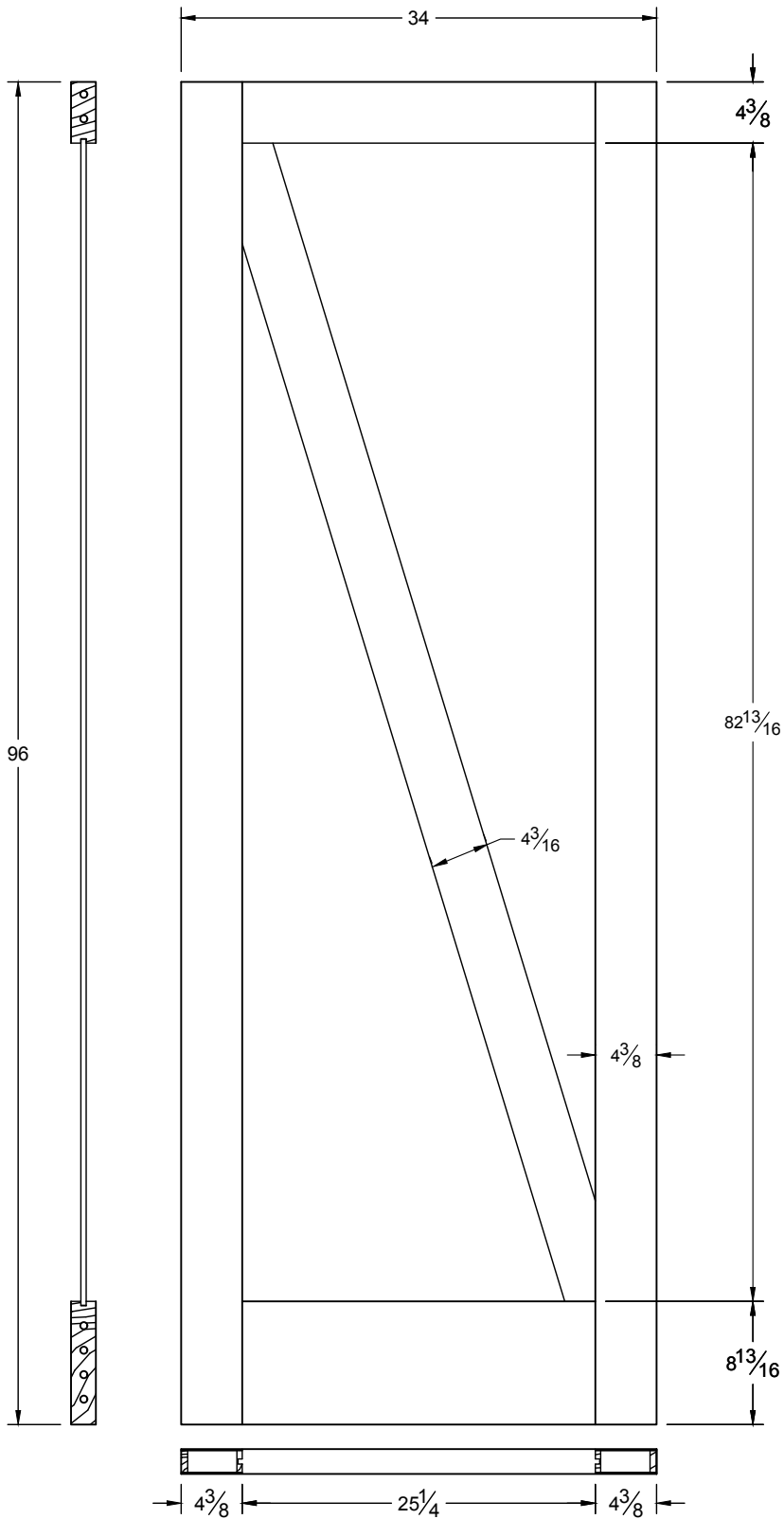

This drawing contains information which is the property of Woodgrain Millwork, Inc. This drawing is received on confidence and contents may not be disclosed without the prior written consent of Woodgrain Millwork, Inc.

4180

Draw #:	Shaker 4180_34_96
Date:	11 - 01 - 17
Drawn By:	T Doughty



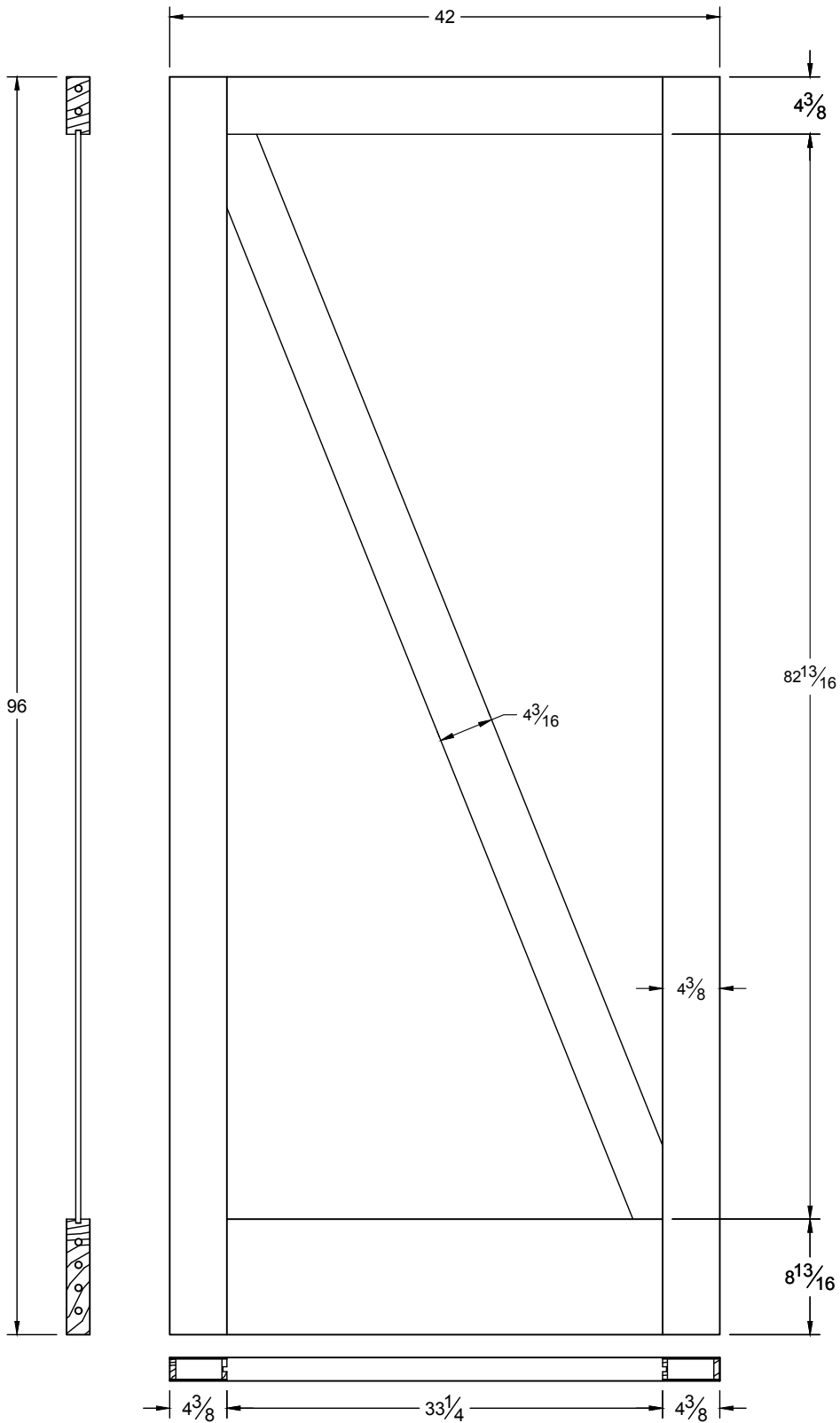

This drawing contains information which is the property of Woodgrain Millwork, Inc. This drawing is received on confidence and contents may not be disclosed without the prior written consent of Woodgrain Millwork, Inc.

4180

Draw #:	Shaker 4180_42_96
Date:	05 - 16 - 18
Drawn By:	T Doughty



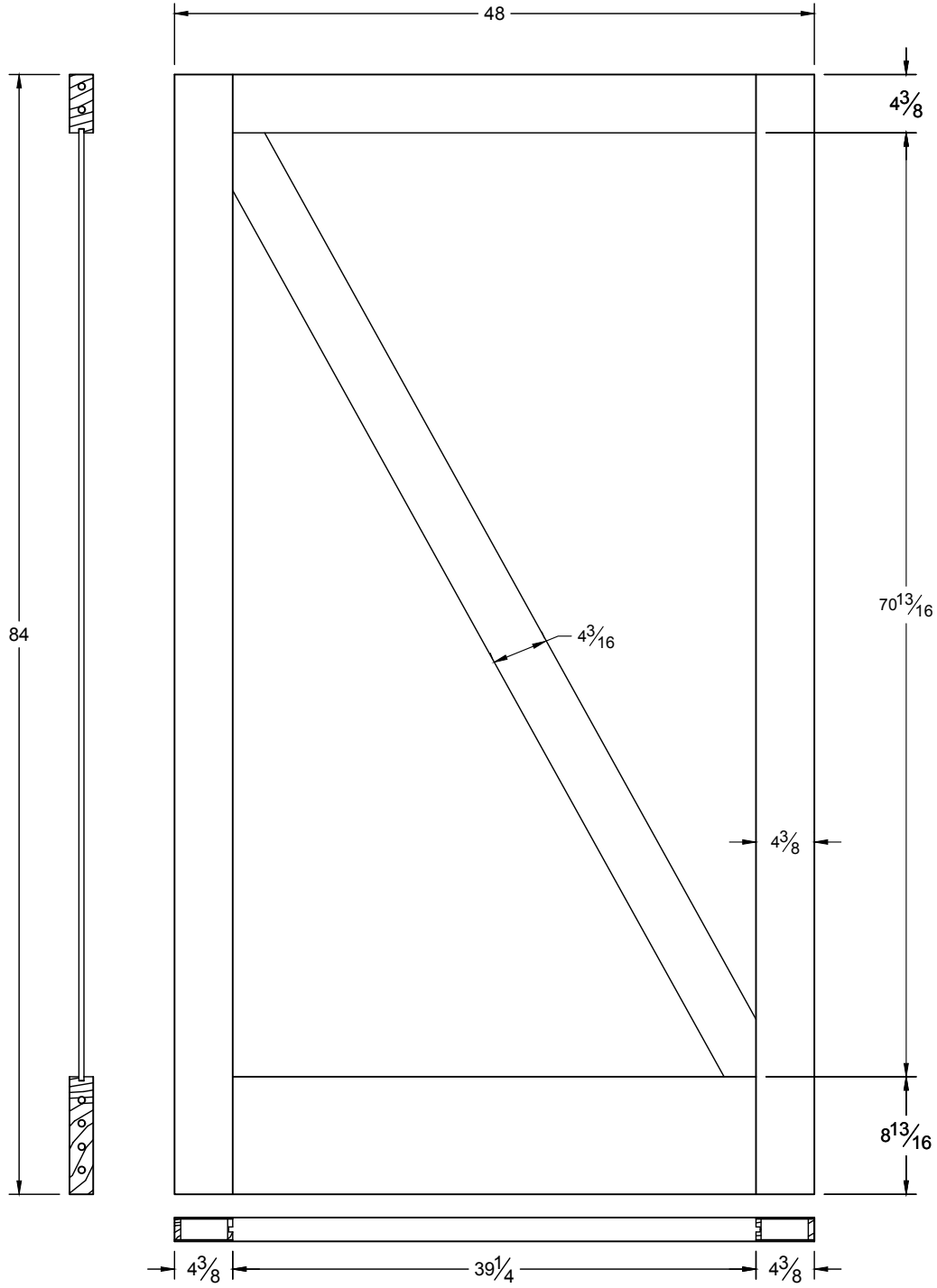

This drawing contains information which is the property of Woodgrain Millwork, Inc. This drawing is received on confidence and contents may not be disclosed without the prior written consent of Woodgrain Millwork, Inc.

4180

Draw #:	Shaker 4180_48_84
Date:	09 - 01 - 17
Drawn By:	T Doughty



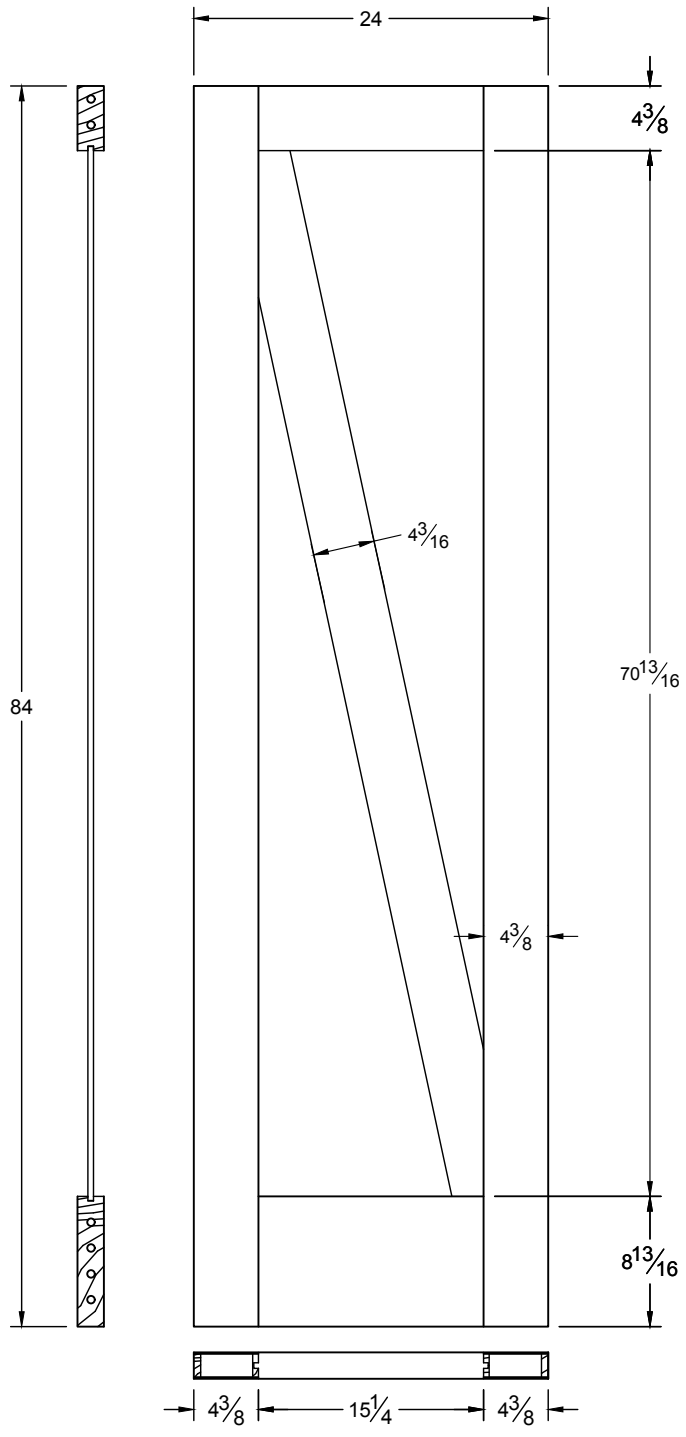

This drawing contains information which is the property of Woodgrain Millwork, Inc. This drawing is received on confidence and contents may not be disclosed without the prior written consent of Woodgrain Millwork, Inc.

4180

Draw #:	Shaker 4180_24_84
Date:	01 - 10 - 17
Drawn By:	T Doughty



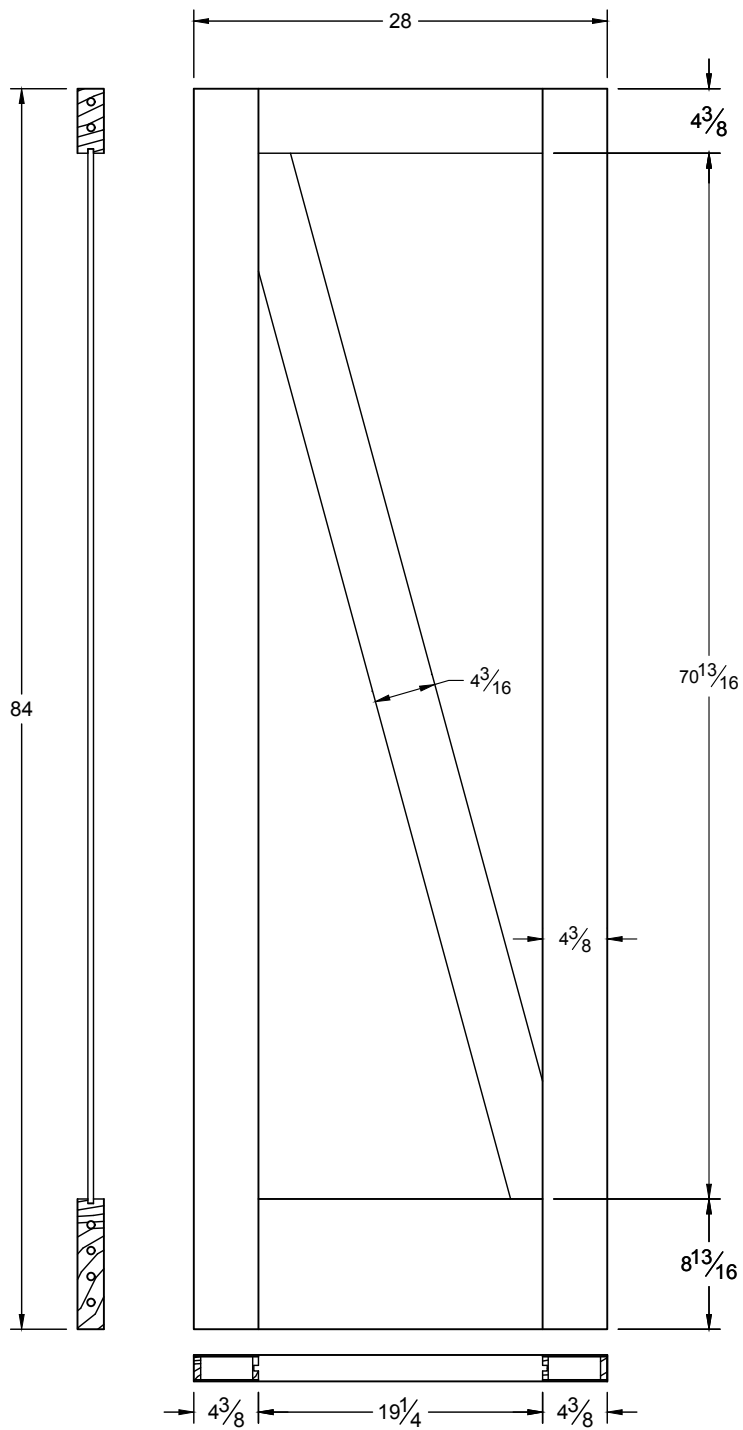

This drawing contains information which is the property of Woodgrain Millwork, Inc. This drawing is received on confidence and contents may not be disclosed without the prior written consent of Woodgrain Millwork, Inc.

4180

Draw #:	Shaker 4180_28_84
Date:	11 - 01 - 17
Drawn By:	T Doughty



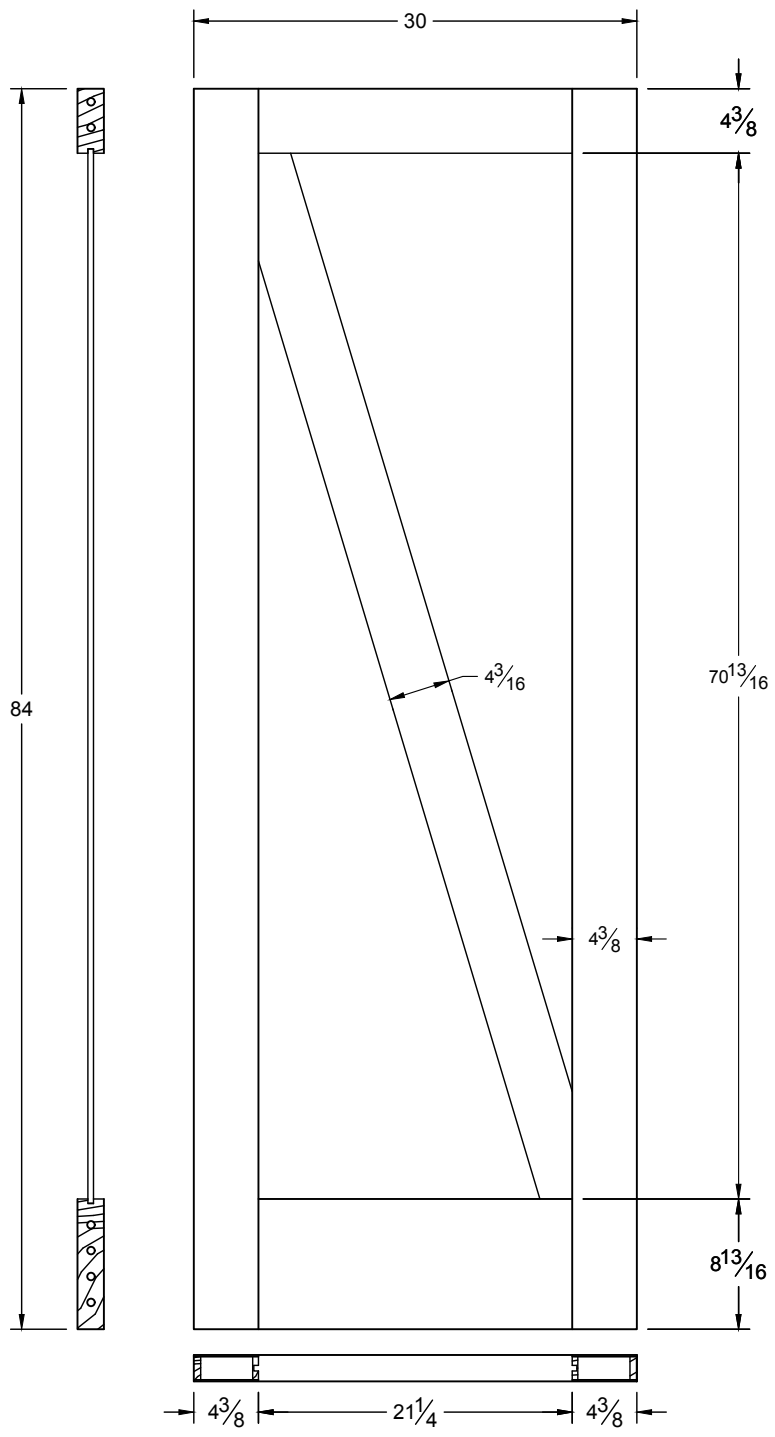

This drawing contains information which is the property of Woodgrain Millwork, Inc. This drawing is received on confidence and contents may not be disclosed without the prior written consent of Woodgrain Millwork, Inc.

4180

Draw #:	Shaker 4180_30_84
Date:	07 - 05 - 18
Drawn By:	T Doughty



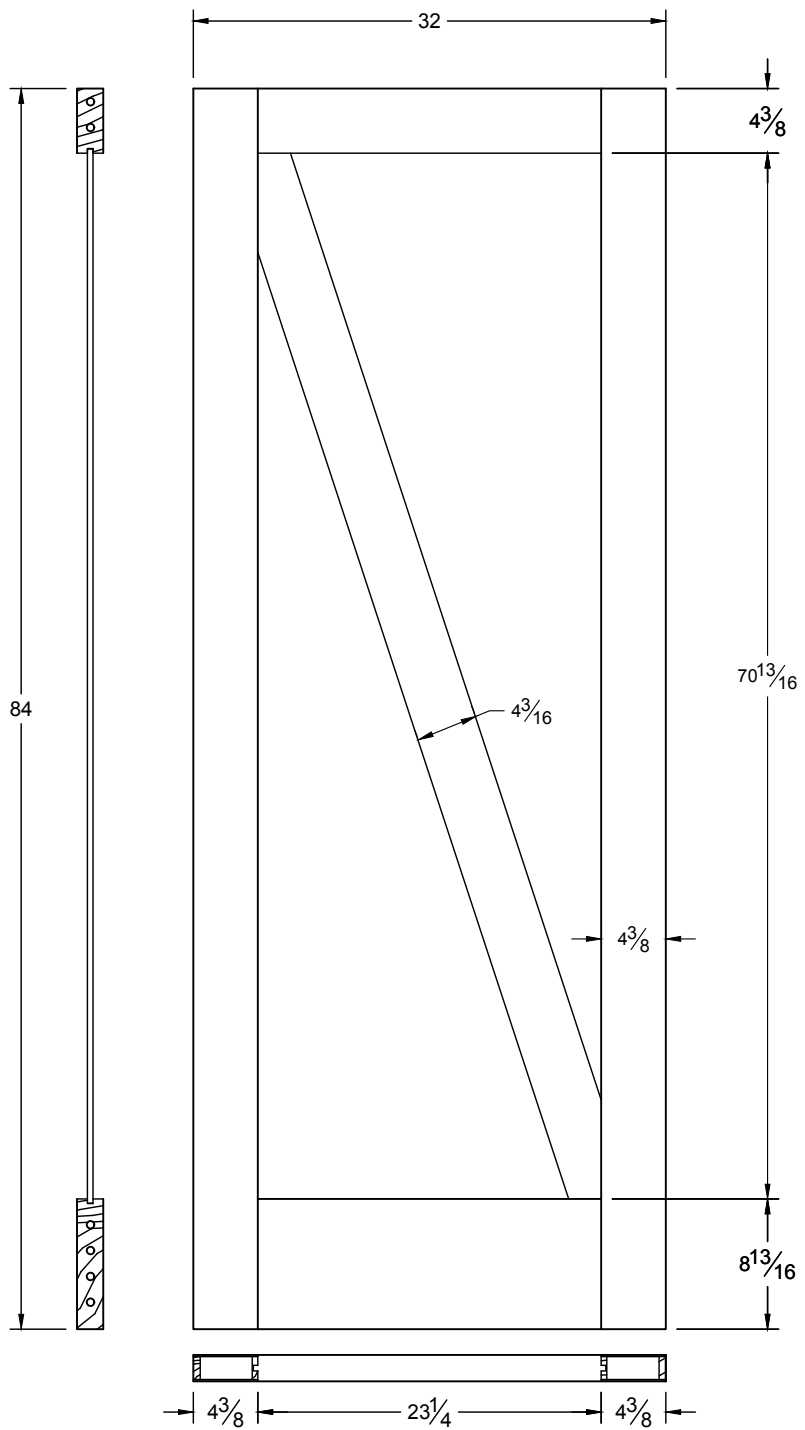

This drawing contains information which is the property of Woodgrain Millwork, Inc. This drawing is received on confidence and contents may not be disclosed without the prior written consent of Woodgrain Millwork, Inc.

4180

Draw #:	Shaker 4180_32_84
Date:	01 - 08 - 17
Drawn By:	T Doughty

 woodgrain doors

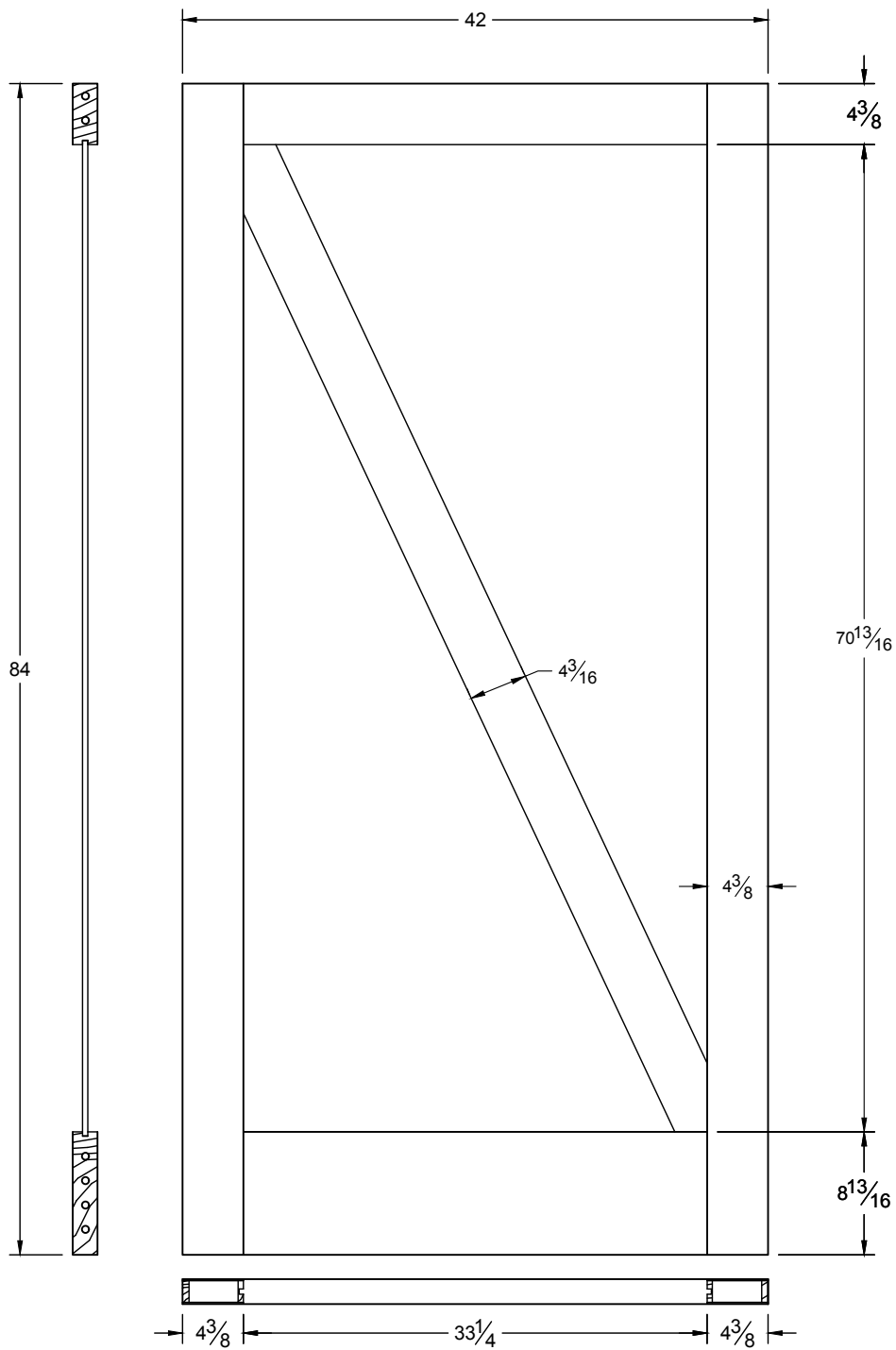

This drawing contains information which is the property of Woodgrain Millwork, Inc. This drawing is received on confidence and contents may not be disclosed without the prior written consent of Woodgrain Millwork, Inc.

4180

Draw #:	Shaker 4180_48_84
Date:	09 - 01 - 17
Drawn By:	T Doughty



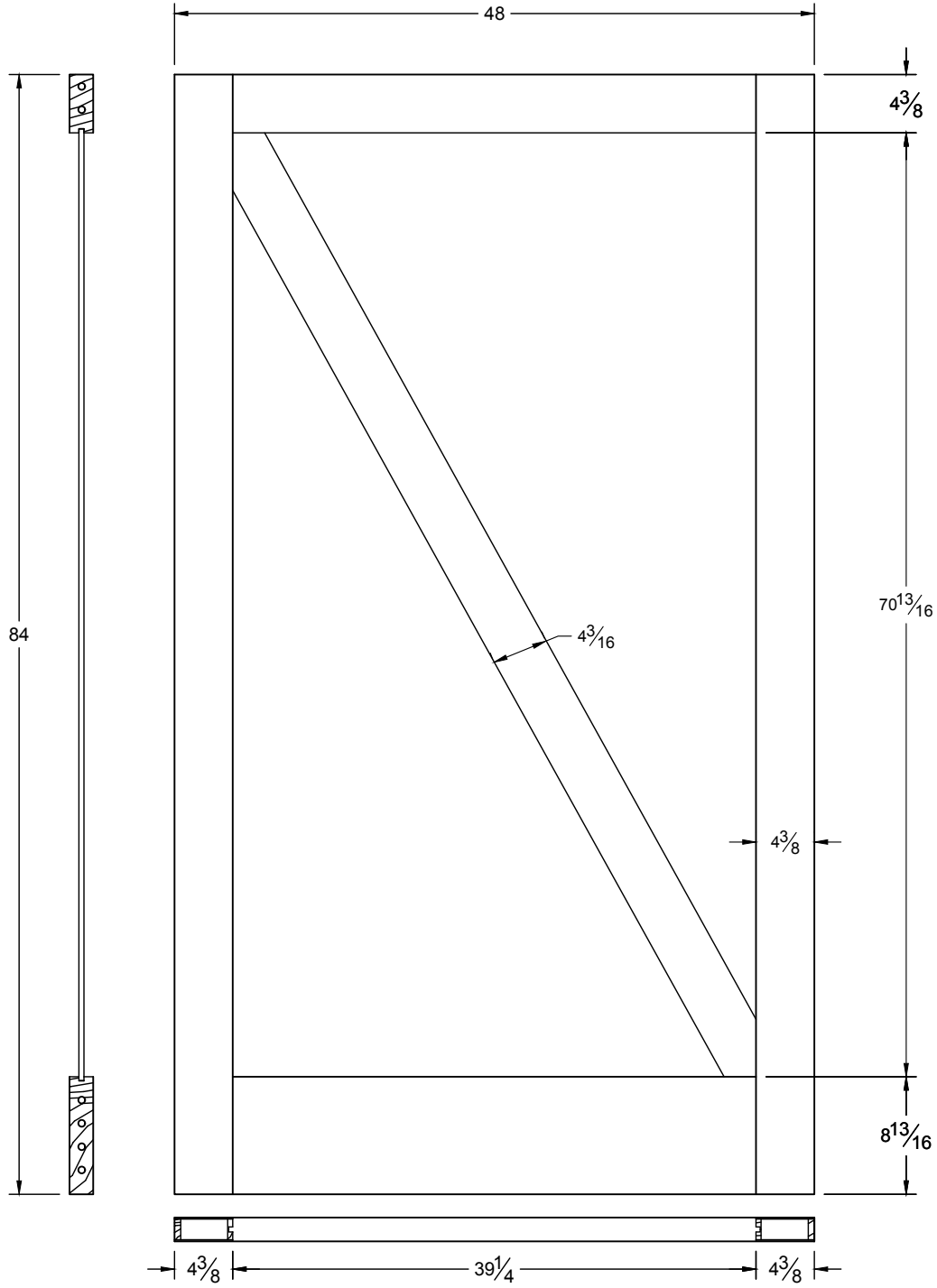

This drawing contains information which is the property of Woodgrain Millwork, Inc. This drawing is received on confidence and contents may not be disclosed without the prior written consent of Woodgrain Millwork, Inc.

4180

Draw #:	Shaker 4180_48_84
Date:	09 - 01 - 17
Drawn By:	T Doughty



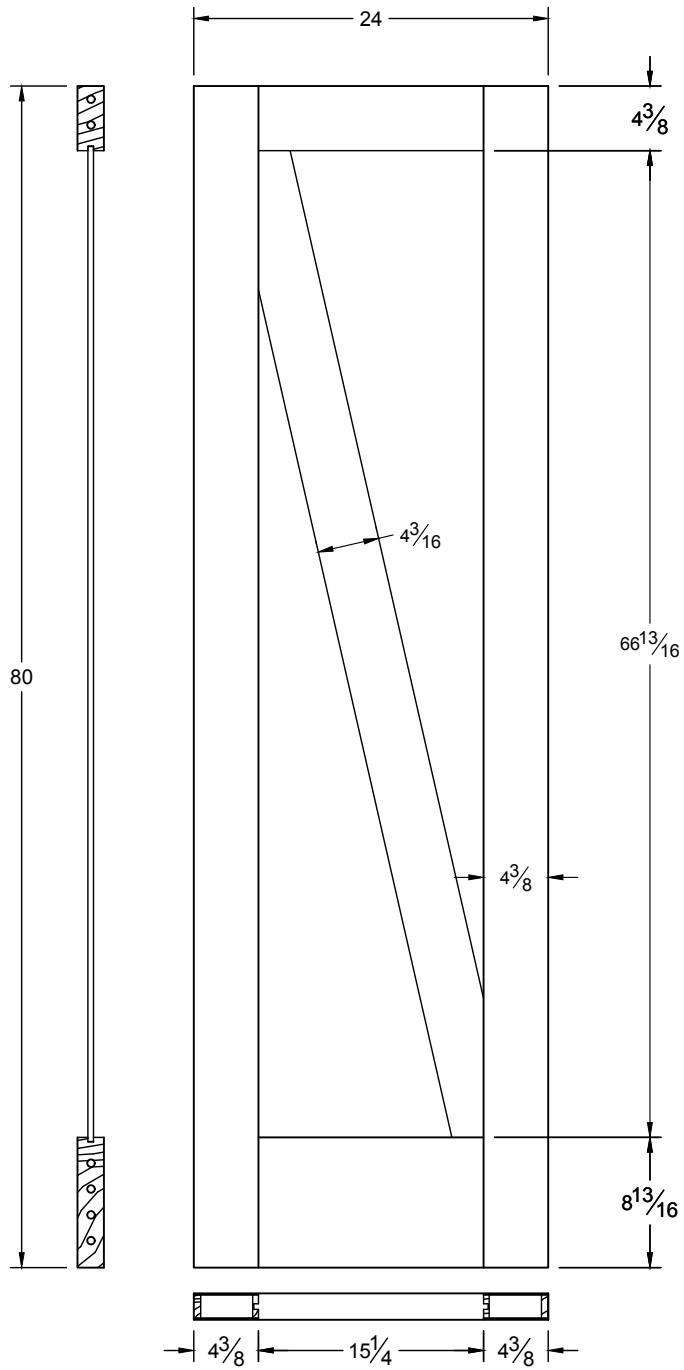

This drawing contains information which is the property of Woodgrain Millwork, Inc. This drawing is received on confidence and contents may not be disclosed without the prior written consent of Woodgrain Millwork, Inc.

4180

Draw #:	Shaker 4180_24_80
Date:	01 - 10 - 17
Drawn By:	T Doughty



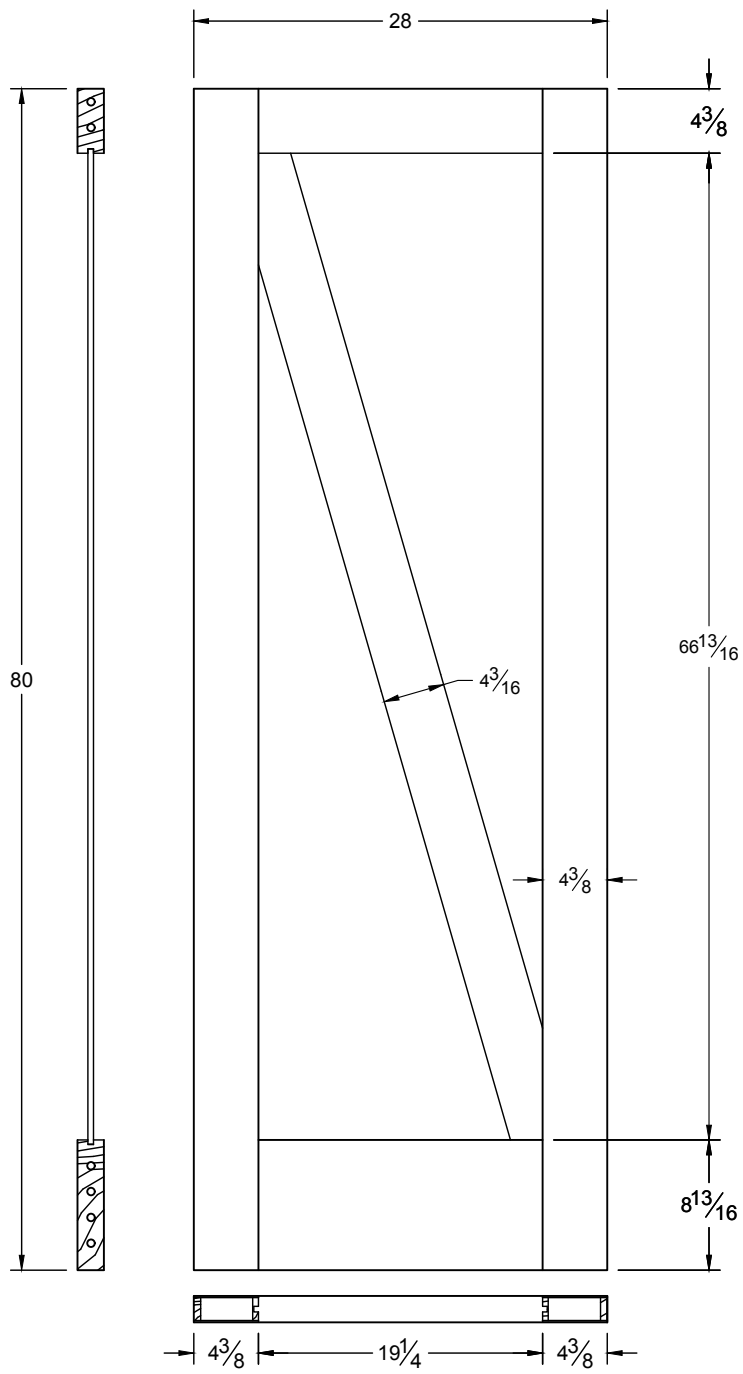

This drawing contains information which is the property of Woodgrain Millwork, Inc. This drawing is received on confidence and contents may not be disclosed without the prior written consent of Woodgrain Millwork, Inc.

4180

Draw #:	Shaker 4180_28_80
Date:	01 - 10 - 17
Drawn By:	T Doughty

 woodgrain doors

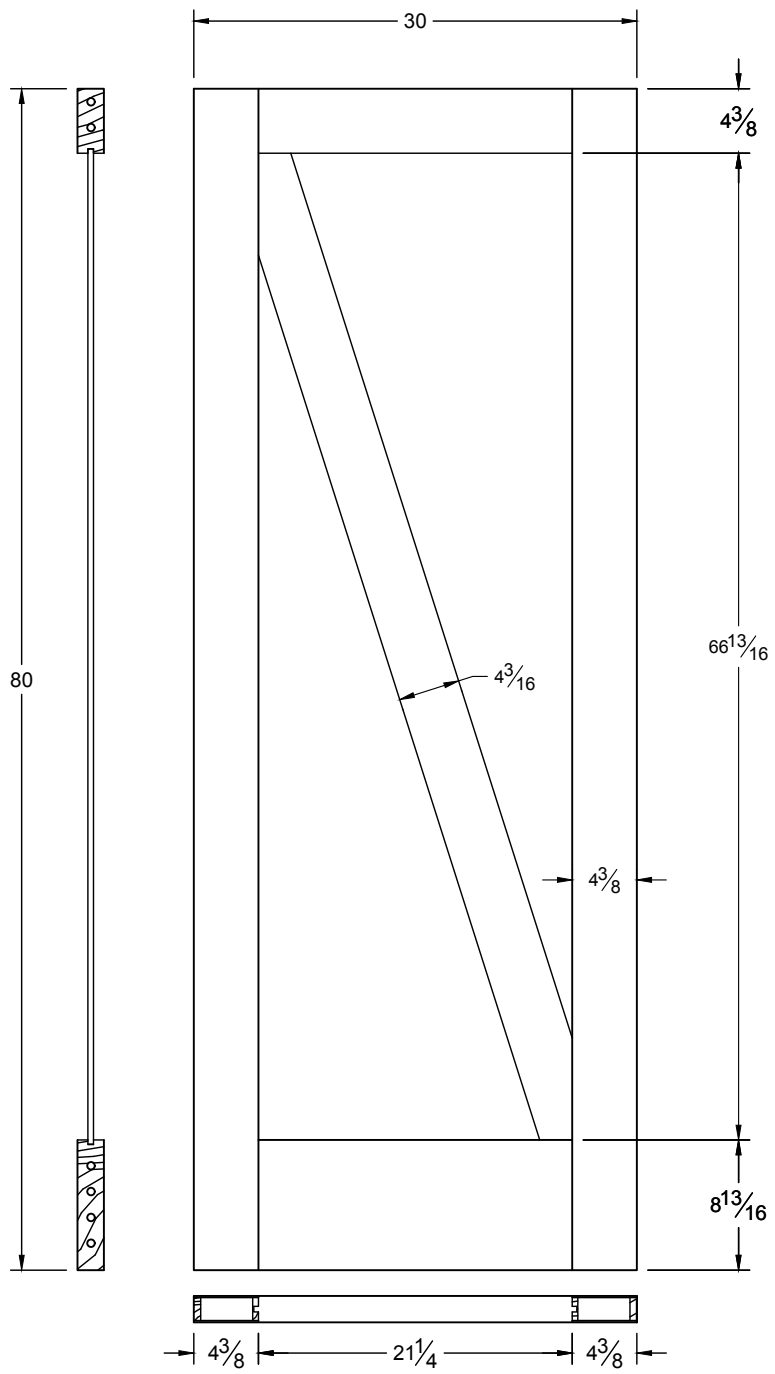

This drawing contains information which is the property of Woodgrain Millwork, Inc. This drawing is received on confidence and contents may not be disclosed without the prior written consent of Woodgrain Millwork, Inc.

4180

Draw #:	Shaker 4180_30_80
Date:	01 - 10 - 17
Drawn By:	T Doughty



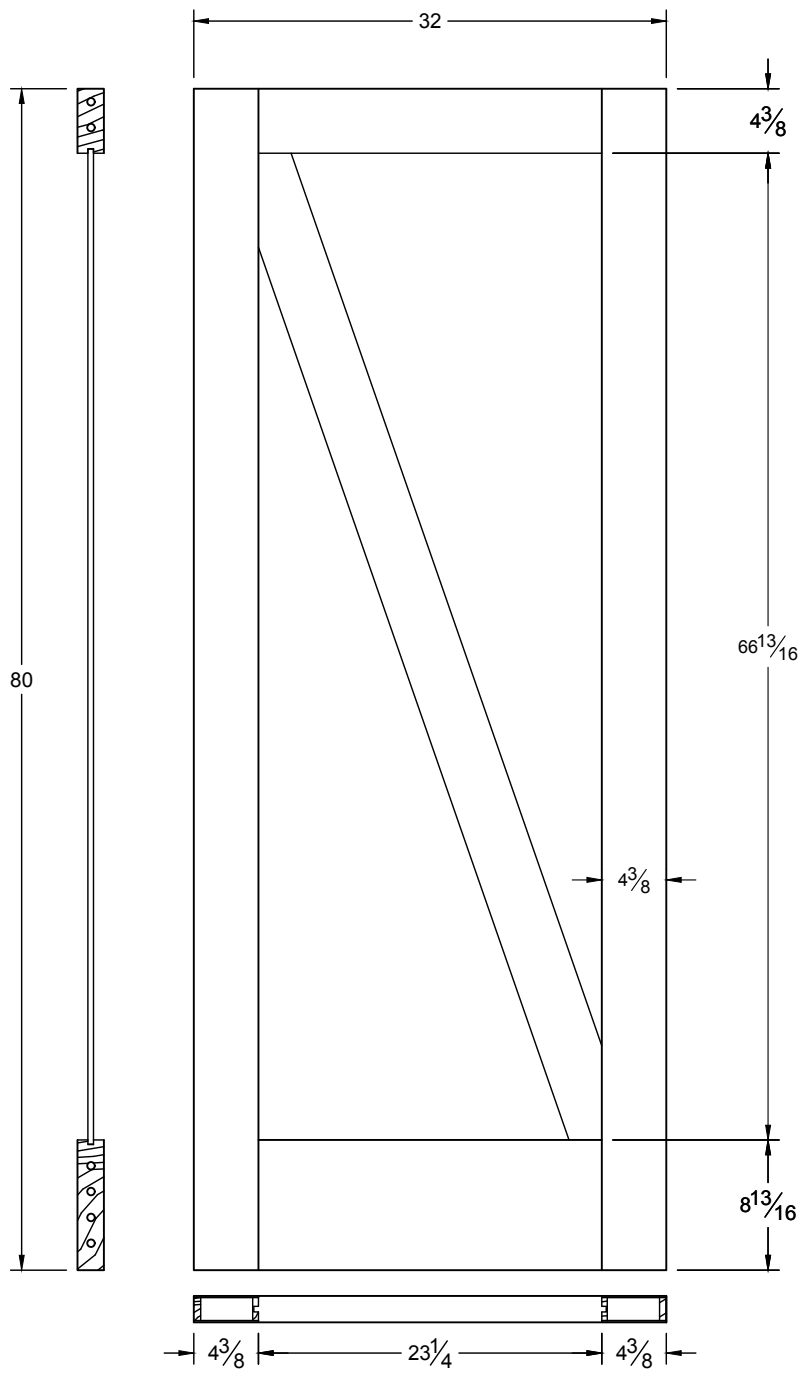

This drawing contains information which is the property of Woodgrain Millwork, Inc. This drawing is received on confidence and contents may not be disclosed without the prior written consent of Woodgrain Millwork, Inc.

4180

Draw #:	Shaker 4180_32_80
Date:	01 - 10 - 17
Drawn By:	T Doughty



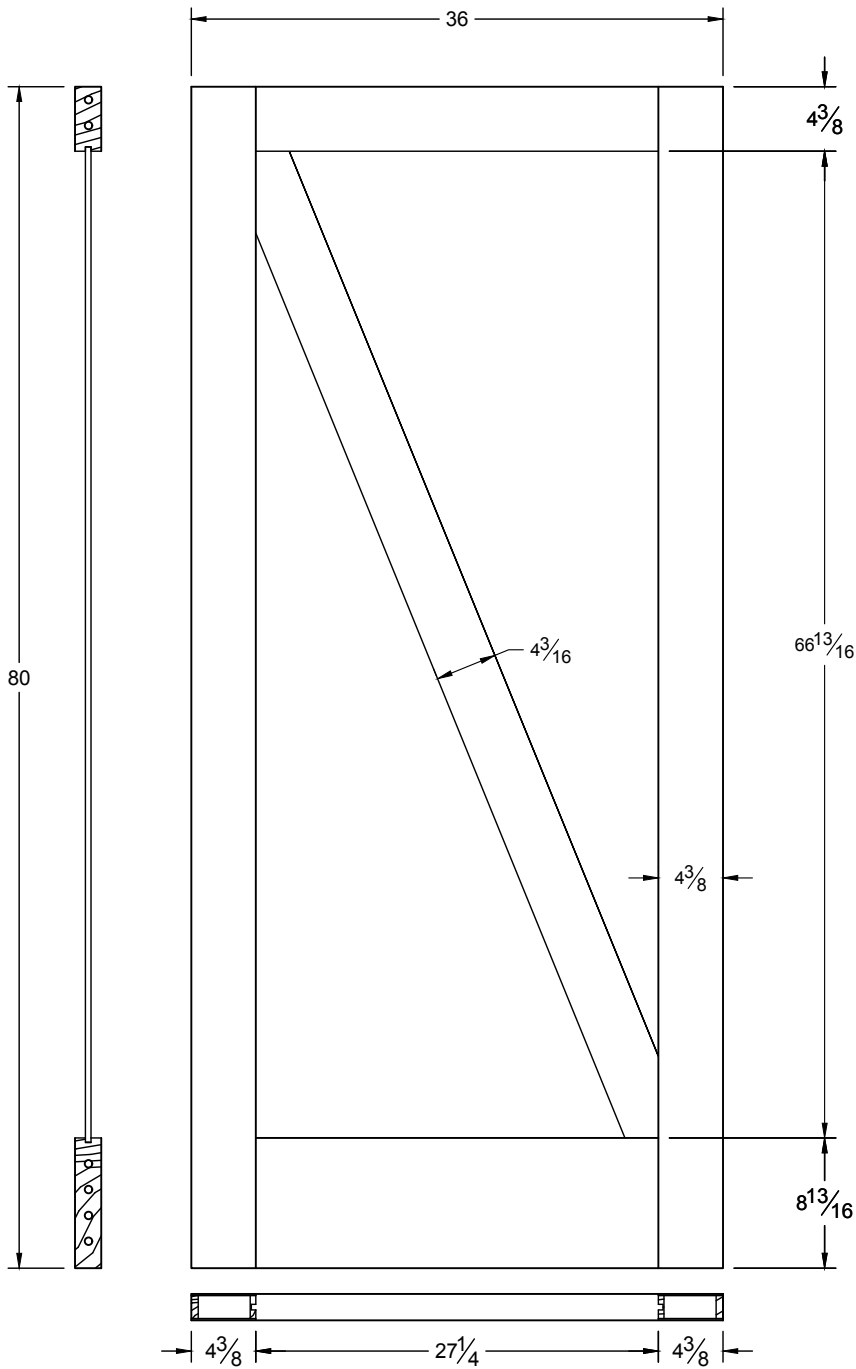

This drawing contains information which is the property of Woodgrain Millwork, Inc. This drawing is received on confidence and contents may not be disclosed without the prior written consent of Woodgrain Millwork, Inc.

4180

Draw #:	Shaker 4180_36_80
Date:	09 - 01 - 17
Drawn By:	T Doughty

